



ET-2500 User's Guide

Contents

ET-2500 User's Guide	11
Your Ink Tank System	12
Product Basics	13
Using the Control Panel	13
Control Panel Buttons and Lights	13
Adjusting Control Panel Position	14
Product Parts Locations	15
Product Parts - Top.....	15
Product Parts - Inside	17
Product Parts - Back.....	18
The Power Off and Sleep Timers	18
Changing the Power and Sleep Timer Settings - Windows.....	19
Changing the Power and Sleep Timer Settings - OS X.....	20
Epson Connect Solutions for Smartphones, Tablets, and More	21
Using Epson Email Print	22
Using the Epson iPrint Mobile App	22
Using Epson Remote Print	23
Wi-Fi Networking	24
Wi-Fi Infrastructure Mode Setup.....	24
Wi-Fi Protected Setup (WPS).....	25
Using WPS to Connect to a Network	25
Printing a Network Status Sheet.....	26
Changing or Updating Network Connections	26
Accessing the Web Config Utility	26
Changing a USB Connection to a Wi-Fi Connection.....	26
Connecting to a New Wi-Fi Router	27
Loading Paper	28
Loading Paper in the Sheet Feeder	28
Paper Loading Capacity	32
Available Epson Papers	33

Paper or Media Type Settings - Product Software.....	34
Placing Originals on the Product	35
Placing Originals on the Scanner Glass	35
Copying	37
Copying Documents or Photos.....	37
Printing from a Computer	38
Printing with Windows	38
Selecting Basic Print Settings - Windows	38
Print Quality Options - Windows	40
Multi-Page Printing Options - Windows.....	41
Selecting Double-sided Printing Settings - Windows	41
Double-sided Printing Options - Windows.....	43
Selecting Additional Layout and Print Options - Windows	44
Custom Color Correction Options - Windows.....	46
Image Options and Additional Settings - Windows.....	47
Header/Footer Settings - Windows	47
Selecting a Printing Preset - Windows	48
Selecting Extended Settings - Windows	50
Extended Settings - Windows	51
Printing Your Document or Photo - Windows.....	52
Checking Print Status - Windows	54
Selecting Default Print Settings - Windows.....	54
Changing the Language of the Printer Software Screens	55
Changing Automatic Update Options	56
Printing with OS X	57
Selecting Basic Print Settings - OS X	58
Print Quality Options - Mac OS X.....	62
Print Options - OS X.....	62
Selecting Page Setup Settings - OS X.....	62
Selecting Print Layout Options - OS X.....	63
Sizing Printed Images - OS X	64
Managing Color - OS X.....	64
Color Matching and Color Options - OS X.....	65

Selecting Printing Preferences - OS X.....	66
Printing Preferences - OS X.....	67
Printing Your Document or Photo - OS X.....	68
Checking Print Status - OS X.....	68
Cancelling Printing Using a Product Button.....	69
Scanning.....	70
Starting a Scan.....	70
Starting a Scan Using the Product Buttons.....	70
Changing Default Scan Button Settings.....	70
Starting a Scan Using the Epson Scan Icon.....	71
Starting a Scan from a Scanning Program.....	73
Selecting Epson Scan Settings.....	75
Scan Modes.....	75
Selecting the Scan Mode.....	76
Scanning in Full Auto Mode.....	76
Available Image Adjustments - Full Auto Mode.....	79
Scanning in Home Mode.....	79
Selecting a Scan Area - Home Mode.....	82
Available Image Adjustments - Home Mode.....	85
Selecting a Scan Size - Home Mode.....	86
Scanning in Office Mode.....	89
Selecting a Scan Area - Office Mode.....	90
Available Image Adjustments - Office Mode.....	92
Scanning in Professional Mode.....	93
Available Image Types - Professional Mode.....	96
Selecting a Scan Area - Professional Mode.....	96
Available Image Adjustments - Professional Mode.....	99
Selecting a Scan Size - Professional Mode.....	101
Image Preview Guidelines.....	104
Scan Resolution Guidelines.....	104
Selecting Scan File Settings.....	106
Available Scanned File Types and Optional Settings.....	107
Scanning with OS X Using Image Capture.....	108

Available Scan Settings - OS X Image Capture	110
Scanning Special Projects.....	110
Scanning to a PDF File.....	111
Restoring Photo Colors as You Scan	114
Refilling Ink.....	116
Ink Safety Precautions	116
Check Ink Levels.....	117
Disabling Special Offers with Windows	118
Purchase Epson Ink	119
Ink Bottle Part Numbers.....	120
Refilling the Ink Tanks	120
Adjusting Print Quality.....	125
Print Head Maintenance.....	125
Print Head Nozzle Check.....	125
Checking the Nozzles Using the Product Buttons	125
Checking the Nozzles Using a Computer Utility.....	127
Print Head Cleaning	128
Cleaning the Print Head Using the Product Buttons.....	129
Cleaning the Print Head Using a Computer Utility.....	129
Power Ink Flushing	132
Flushing the Ink Using a Computer Utility	132
Print Head Alignment	133
Aligning the Print Head Using a Computer Utility.....	134
Cleaning the Paper Path	136
Checking the Number of Sheets.....	137
Checking the Sheet Counter - Windows	137
Checking the Sheet Counter - OS X	138
Cleaning and Transporting Your Product	140
Cleaning Your Product	140
Transporting Your Product	140
Solving Problems	144
Checking for Software Updates.....	144

Product Light Status	145
Running a Product Check	147
Solving Setup Problems	147
Noise After Filling the Ink	148
Software Installation Problems	148
USB Connection Problems	149
Solving Network Problems	149
Product Cannot Connect to a Wireless Router or Access Point	149
Network Software Cannot Find Product on a Network	150
Product Does Not Appear in OS X Printer Window	151
Cannot Print Over a Network	152
Cannot Scan Over a Network	153
Solving Copying Problems	154
Product Makes Noise, But Nothing Copies	154
Product Makes Noise When It Sits for a While	154
Solving Paper Problems	154
Paper Feeding Problems	155
Paper Jam Problems Inside the Product	155
Paper Ejection Problems	158
Solving Problems Printing from a Computer	158
Nothing Prints	158
Product Icon Does Not Appear in Windows Taskbar	159
Printing is Slow	160
Solving Page Layout and Content Problems	161
Inverted Image	161
Too Many Copies Print	162
Blank Pages Print	162
Incorrect Margins on Printout	162
Incorrect Characters Print	163
Incorrect Image Size or Position	163
Slanted Printout	164
Solving Print Quality Problems	164
White or Dark Lines in Printout	165

Blurry or Smearred Printout	166
Faint Printout or Printout Has Gaps	167
Grainy Printout.....	168
Incorrect Colors	169
Solving Scanning Problems	170
Scanning Software Does Not Operate Correctly	170
Cannot Start Epson Scan	171
Solving Scanned Image Quality Problems	171
Image Consists of a Few Dots Only.....	172
Line of Dots Appears in All Scanned Images.....	172
Straight Lines in an Image Appear Crooked	173
Image is Distorted or Blurry	173
Image Colors are Patchy at the Edges	174
Image is Too Dark	174
Back of Original Image Appears in Scanned Image	174
Ripple Patterns Appear in an Image	174
Image is Scanned Upside-Down	175
Scanned Image Colors Do Not Match Original Colors.....	175
Scan Area is Not Adjustable in Thumbnail Preview	175
Scanned Image Edges are Cropped	176
Uninstall Your Product Software.....	176
Uninstalling Product Software - Windows.....	176
Uninstalling Product Software - OS X.....	177
Where to Get Help.....	178
Technical Specifications	180
Windows System Requirements	180
OS X System Requirements.....	181
Scanning Specifications	181
Paper Specifications	182
Printable Area Specifications	183
Ink Specifications	184
Dimension Specifications	185
Electrical Specifications	185

Environmental Specifications	186
Interface Specifications	186
Network Interface Specifications	186
Safety and Approvals Specifications	187
Notices	188
Important Safety Instructions.....	188
General Product Safety Instructions	188
Wireless Connection Safety Instructions	190
FCC Compliance Statement.....	190
Trademarks	191
Copyright Notice.....	191
A Note Concerning Responsible Use of Copyrighted Materials.....	192
Default Delay Times for Power Management for Epson Products	192
Copyright Attribution	192

ET-2500 User's Guide

Welcome to the ET-2500 *User's Guide*.

For a printable PDF copy of this guide, [click here](#).

Your Ink Tank System

You should visually check the ink levels in the product's ink tanks regularly.

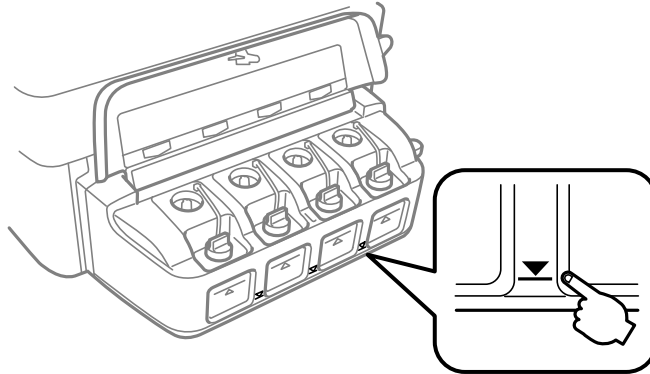

Caution: If the ink level is below the lower line on the ink tank, fill it to the upper line on the ink tank. Continued use of the product when the ink level is below the lower line on the tank could damage the product.

To refill the ink tanks, click the link below.

Related topics

[Refilling Ink](#)

Product Basics

See these sections to learn about the basic features of your product.

[Using the Control Panel](#)

[Product Parts Locations](#)

[The Power Off and Sleep Timers](#)

[Epson Connect Solutions for Smartphones, Tablets, and More](#)

Using the Control Panel

See these sections to learn about the control panel and select control panel settings.

[Control Panel Buttons and Lights](#)

[Adjusting Control Panel Position](#)

Parent topic: [Product Basics](#)

Control Panel Buttons and Lights

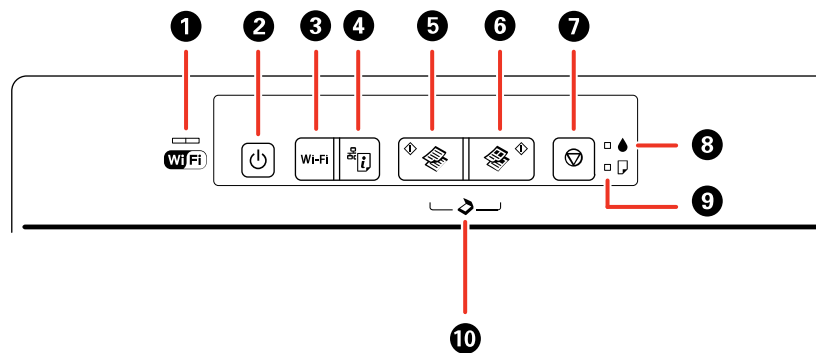

1 The WiFi light

The left side of the WiFi light turns solid green when the product is connected to a wireless network and flashes when the product is communicating over a network. The right side flashes orange if a problem occurs with the product's wireless network connection. Both sides flash alternately or simultaneously while the product is setting up a connection with a wireless network.

2 The  power button and the  power light

- 3 The **Wi-Fi** button
- 4 The  network status button
- 5 The  B&W copy button
- 6 The  color copy button
- 7 The  stop button
- 8 The  ink light
- 9 The  paper light
- 10 Scan to PDF by pressing the  B&W copy button and the  color copy button simultaneously

Parent topic: [Using the Control Panel](#)

Adjusting Control Panel Position

You can adjust the position of the control panel to make it easier to use.

- To raise the control panel, lift it up from the bottom.
- To lower the control panel, squeeze the release bar and gently push the panel down.

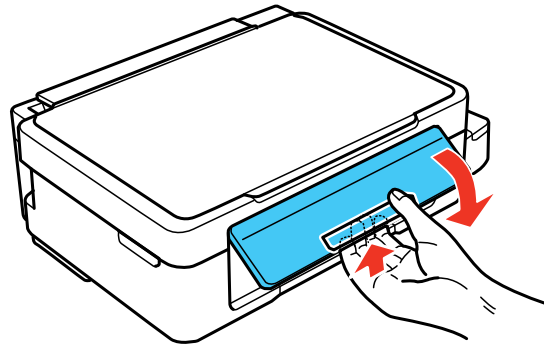

Caution: Do not lower the control panel without first squeezing the release bar or you may damage your product.

Parent topic: [Using the Control Panel](#)

Product Parts Locations

See these sections to identify the parts on your product.

[Product Parts - Top](#)

[Product Parts - Inside](#)

[Product Parts - Back](#)

Parent topic: [Product Basics](#)

Product Parts - Top

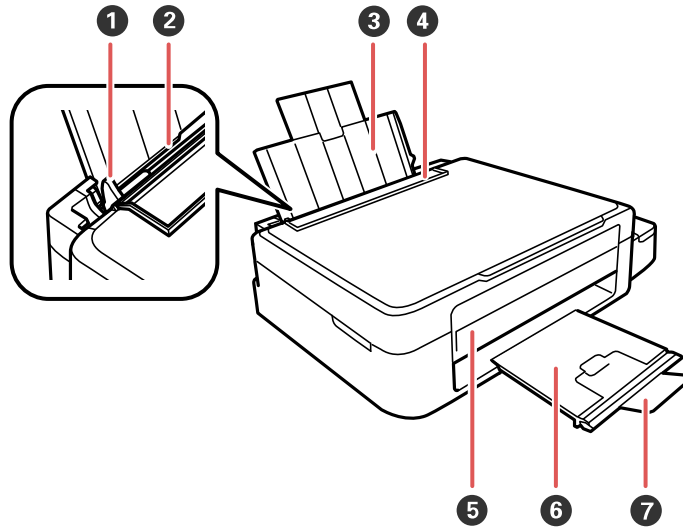

- 1 Edge guide
- 2 Sheet feeder
- 3 Paper support
- 4 Feeder guard
- 5 Control panel
- 6 Output tray
- 7 Paper stopper

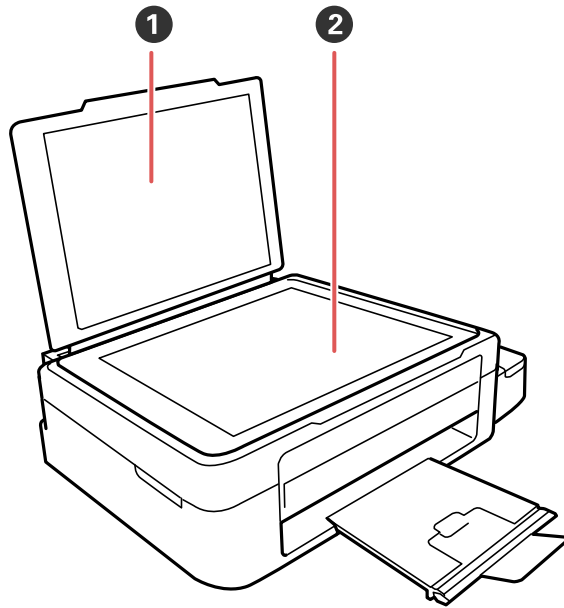

- 1 Document cover
- 2 Scanner glass

Parent topic: [Product Parts Locations](#)

Product Parts - Inside

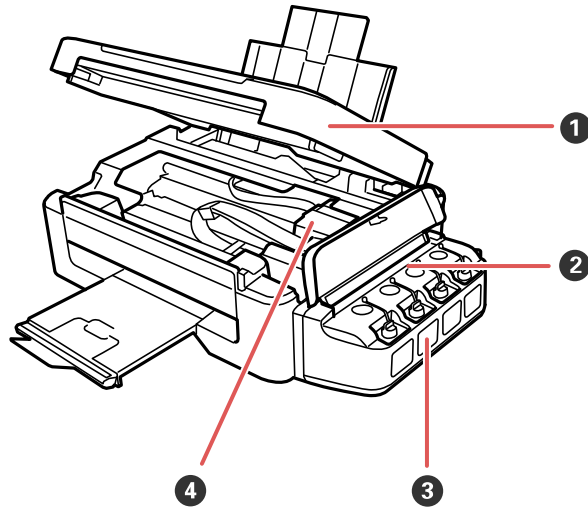

- 1 Scanner unit
- 2 Ink tank unit
- 3 Ink tanks
- 4 Print head in home position

Parent topic: [Product Parts Locations](#)

Product Parts - Back

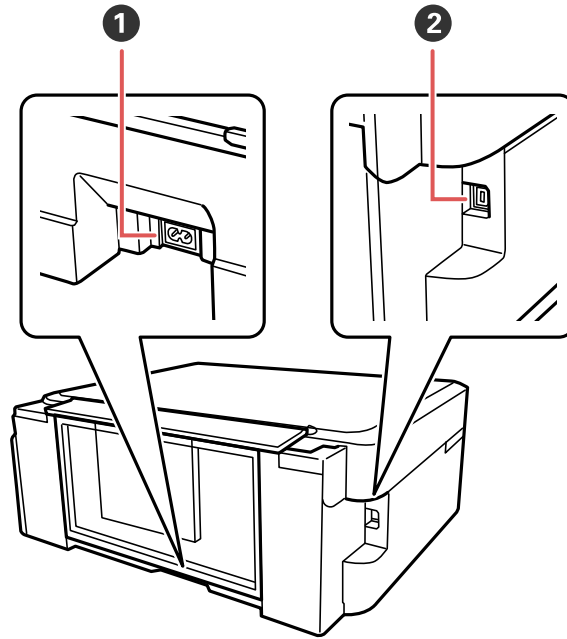

- 1 AC inlet
- 2 USB port

Parent topic: [Product Parts Locations](#)

The Power Off and Sleep Timers

The product enters sleep mode or turns off automatically if it is not used for a period of time. You can adjust the time period before power management, but increasing the time reduces the product's energy efficiency.

[Changing the Power and Sleep Timer Settings - Windows](#)

[Changing the Power and Sleep Timer Settings - OS X](#)

Parent topic: [Product Basics](#)

Changing the Power and Sleep Timer Settings - Windows

You can use the printer software to change the time period before the product enters sleep mode or turns off automatically.

1. Make sure your product is turned on.
2. Access the Windows Desktop and right-click the product icon in the Windows taskbar.
3. Select **Printer Settings**.
4. Click the **Maintenance** tab.
5. Click the **Printer and Option Information** button.

You see this screen:

The screenshot shows a dialog box titled "Printer and Option Information" with a light blue border. It contains three main sections:

- Power Off Timer:** The current printer setting is "Off". There is a dropdown menu showing "Off" and a "Send" button to the right.
- Sleep Timer:** The current printer setting is "10 minutes". There is a dropdown menu showing "10 minutes" and a "Send" button to the right.
- Number of Sheets of Paper Fed into the Printer:** A text box contains the number "8". Below the text box is a horizontal line. A note states: "The number of sheets is displayed when EPSON Status Monitor 3 is enabled."

At the bottom of the dialog box are three buttons: "OK", "Cancel", and "Help".

6. Select the length of time after which you want the product to automatically turn off when it is not in use as the **Power Off Timer** setting.
7. Click **Send**.
8. Select the time period you want before the product goes to sleep as the **Sleep Timer** setting.
9. Click **Send**.
10. Click **OK** to close the open program windows.

Parent topic: [The Power Off and Sleep Timers](#)

Changing the Power and Sleep Timer Settings - OS X

You can use the printer software to change the time period before the product enters sleep mode or turns off automatically.

1. Make sure your product is turned on.
2. In the Apple menu or the Dock, select **System Preferences**. Select **Print & Fax**, **Print & Scan**, or **Printers & Scanners**, select your product, and select **Options & Supplies**. Select **Utility** and select **Open Printer Utility**.
3. Select **Printer Settings**.

You see this window:

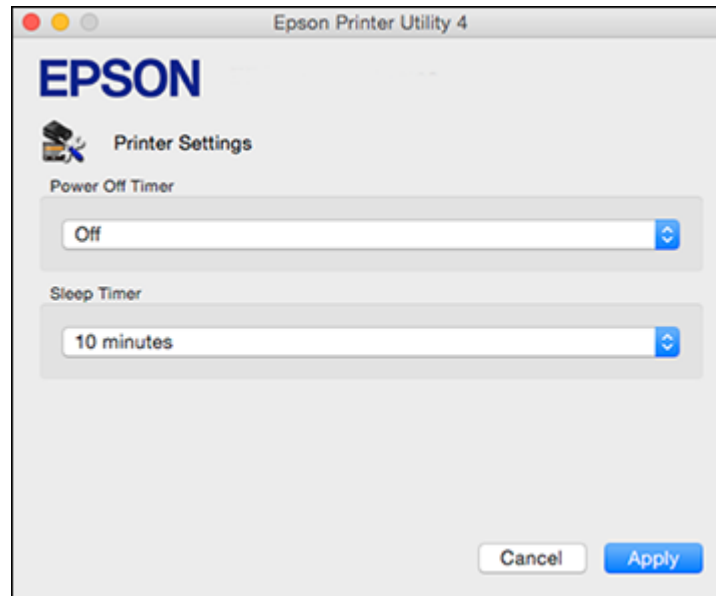

4. Select the length of time after which you want the product to automatically turn off when it is not in use as the **Power Off Timer** setting.
5. Select the time period you want before the product goes to sleep as the **Sleep Timer** setting.
6. Click **Apply**.
7. Close the Printer Settings window.

Parent topic: [The Power Off and Sleep Timers](#)

Epson Connect Solutions for Smartphones, Tablets, and More

You can print documents, photos, emails, and web pages from your home, office, or even across the globe. You can use your smartphone, tablet, or computer. Epson offers these solutions to print from anywhere: Epson Email Print, Epson iPrint Mobile App, and Epson Remote Print.

[Using Epson Email Print](#)

[Using the Epson iPrint Mobile App](#)

[Using Epson Remote Print](#)

Parent topic: [Product Basics](#)

Using Epson Email Print

With Epson Email Print, you can print from any device that can send email, such as your smartphone, tablet, or laptop. Just activate your product's unique email address. When you want to print, attach a PDF, Microsoft Office document, or photo to an email and send it to your product.

1. Set up your product for network printing. See the link below.
2. If you did not already set up Email Print when you installed your product software, visit epson.com/connect to learn more about Email Print, check compatibility, and get detailed setup instructions.
3. Send an email with attachments to your product's Email Print address.

Note: Both the email and any attachments print by default. You can change these printing options by logging into your Epson Connect account.

Parent topic: [Epson Connect Solutions for Smartphones, Tablets, and More](#)

Related topics

[Wi-Fi Networking](#)

Using the Epson iPrint Mobile App

Use this free Apple and Android app to print to nearby Epson networked products. The Epson iPrint Mobile App lets you print PDFs, Microsoft Office documents, photos, and web pages over a wireless network. You can even scan and save a file on your device, send it as an email, or upload it to an online service such as Box, Dropbox, Evernote, or Google Drive.

1. Set up your product on a network. See the link below.
2. Visit epson.com/connect to learn more about Epson iPrint and check the compatibility of your mobile device.
3. Download Epson iPrint from the Apple App Store or Google Play.
4. Connect your mobile device to the same wireless network that your product is using.
5. Print from your mobile device to your Epson product.

Parent topic: [Epson Connect Solutions for Smartphones, Tablets, and More](#)

Related topics

[Wi-Fi Networking](#)

Using Epson Remote Print

With Epson Remote Print software, you can print to an Epson Email-enabled product anywhere in the world.

1. Set up your product for network printing. See the link below.
2. Visit [epson.com/connect](https://www.epson.com/connect) to learn more about Remote Print and how to download the software.
3. Download and install the Remote Print software.
4. Obtain the email address and optional access key of the Epson product you want to use for printing, and enter this address during Remote Print setup.
5. Select the print command in your application and choose the Remote Print driver for your Epson product.

Parent topic: [Epson Connect Solutions for Smartphones, Tablets, and More](#)

Related topics

[Wi-Fi Networking](#)

Wi-Fi Networking

See these sections to use your product on a Wi-Fi network.

[Wi-Fi Infrastructure Mode Setup](#)

[Wi-Fi Protected Setup \(WPS\)](#)

[Printing a Network Status Sheet](#)

[Changing or Updating Network Connections](#)

Wi-Fi Infrastructure Mode Setup

You can set up your product to communicate with your computer using a wireless router or access point. The wireless router or access point can be connected to your computer over a wireless or wired network.

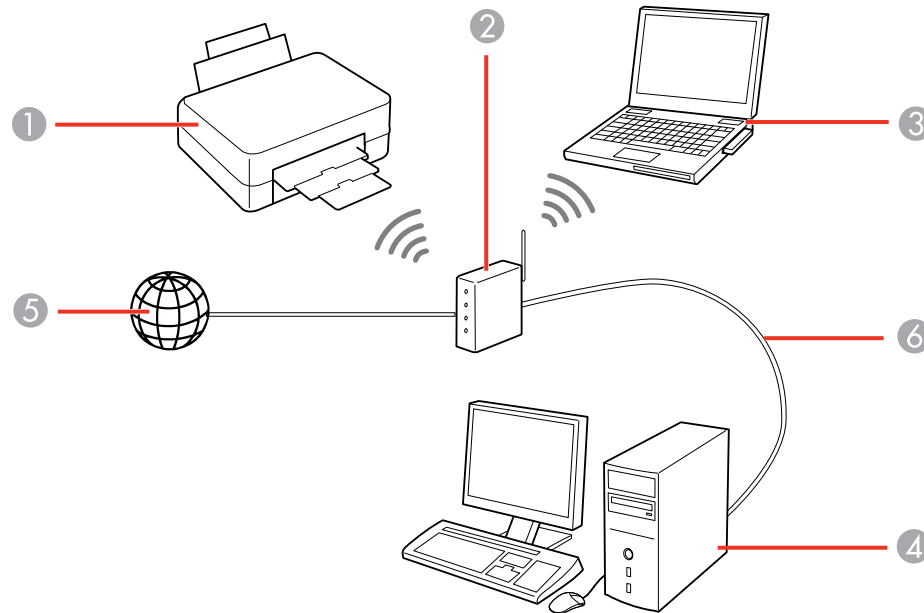

- 1 Epson product
- 2 Wireless router or access point
- 3 Computer with a wireless interface

- 4 Computer
- 5 Internet
- 6 Ethernet cable (used only for wired connection to the wireless router or access point)

Parent topic: [Wi-Fi Networking](#)

Wi-Fi Protected Setup (WPS)

If your network uses a WPS-enabled wireless router or access point, you can quickly connect your product to the network using Wi-Fi Protected Setup (WPS).

Note: To check if your router is WPS-enabled, look for a button labeled **WPS** on your router or access point. If there is no hardware button, there may be a virtual WPS button in the software for the device. Check your network product documentation for details.

[Using WPS to Connect to a Network](#)

Parent topic: [Wi-Fi Networking](#)

Using WPS to Connect to a Network

If you have a WPS-enabled router or access point, you can use Wi-Fi Protected Setup (WPS) to connect your device to the network.

Note: To check if your router is WPS-enabled, look for a button labeled **WPS** on your router or access point. If there is no hardware button, there may be a virtual WPS button in the software for the device. Check your network product documentation for details.

1. To connect to a WPS-enabled router, press the **WPS** button on your router or access point.
2. Press and hold down the **Wi-Fi** button on your product for 3 seconds.

The left side of the WiFi light turns green to indicate a successful connection.

Note: Be sure to press and hold the **Wi-Fi** button on your product within 2 minutes of pressing the **WPS** button on your router or access point.

Parent topic: [Wi-Fi Protected Setup \(WPS\)](#)

Related references

[Control Panel Buttons and Lights](#)

Printing a Network Status Sheet

You can print a network status sheet to help you determine the causes of any problems you may have using your product on a network.

To print the status sheet, press the  network status button on the product. Examine the settings shown on the network status sheet to diagnose any problems you have.

Parent topic: [Wi-Fi Networking](#)

Changing or Updating Network Connections

See these sections to change or update how your product connects to a network.

[Accessing the Web Config Utility](#)

[Changing a USB Connection to a Wi-Fi Connection](#)

[Connecting to a New Wi-Fi Router](#)

Parent topic: [Wi-Fi Networking](#)

Accessing the Web Config Utility

You can select your product's network settings and confirm its operating status using a web browser. You do this by accessing your product's built-in Web Config utility from a computer or other device that is connected to the same network as your product.

1. Print a network status sheet.
2. Locate the IP Address for your product that is listed on the network status sheet.
3. On a computer or other device connected to the same network as your product, open a web browser.
4. Enter your product's IP address into the address bar.

You see the available Web Config utility options.

Parent topic: [Changing or Updating Network Connections](#)

Related tasks

[Printing a Network Status Sheet](#)

Changing a USB Connection to a Wi-Fi Connection

If you have already connected your product to your computer using a USB connection, you can change to a Wi-Fi connection.

1. Disconnect the USB cable from your product.

2. Uninstall your product software.
3. Download and install your product software from the Epson website using the instructions on the *Start Here* sheet.

Parent topic: [Changing or Updating Network Connections](#)

Related concepts

[Uninstall Your Product Software](#)

Connecting to a New Wi-Fi Router

If you change the wireless router you have been using on your network, you need to update your product's Wi-Fi connection to the new router.

Note: If you switch to a 5 GHz wireless router, set the router to operate in dual band (2.4 GHz and 5 GHz) mode. See your router documentation for instructions.

1. Do one of the following:
 - **Windows:** Uninstall your product software.
 - **OS X:** Go to the next step.
2. Download and install your product software from the Epson website using the instructions on the *Start Here* sheet.

Parent topic: [Changing or Updating Network Connections](#)

Related concepts

[Uninstall Your Product Software](#)

Loading Paper

Before you print, load paper for the type of printing you will do.

[Loading Paper in the Sheet Feeder](#)

[Paper Loading Capacity](#)

[Available Epson Papers](#)

[Paper or Media Type Settings - Product Software](#)

Loading Paper in the Sheet Feeder

You can print documents and photos on a variety of paper types and sizes.

1. Flip the feeder guard forward, then raise the paper support and its extension.

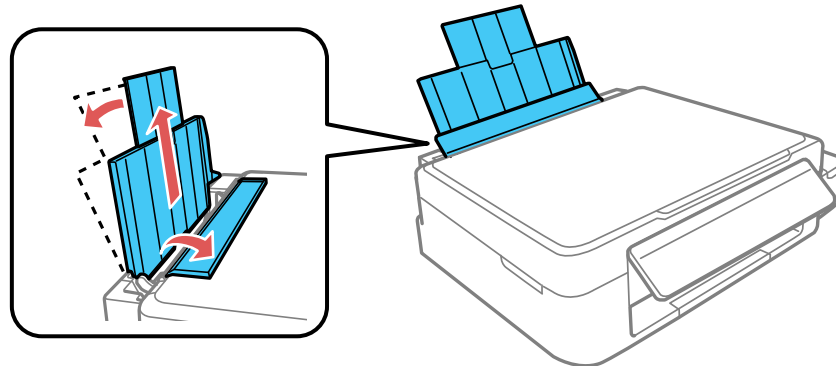

2. Pull out the output tray and open the paper stopper on the end.

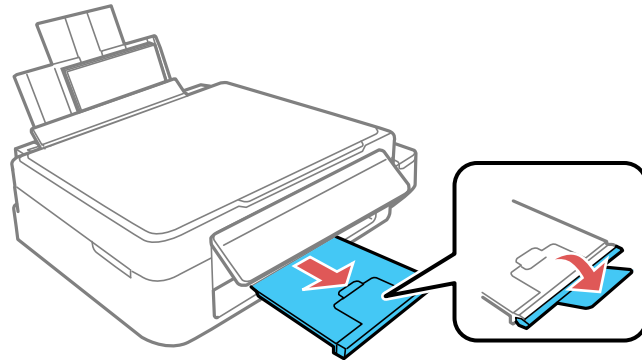

Note: If you print on legal-size or longer paper, leave the paper stopper closed.

3. Slide the edge guide to the left.

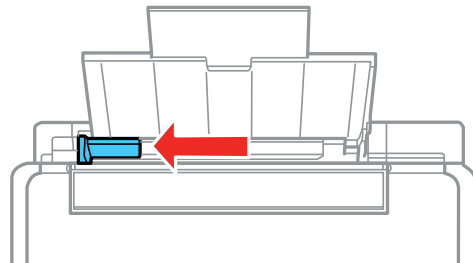

4. If you are inserting a stack of paper, fan the sheets first and tap the stack on a flat surface to even the edges.

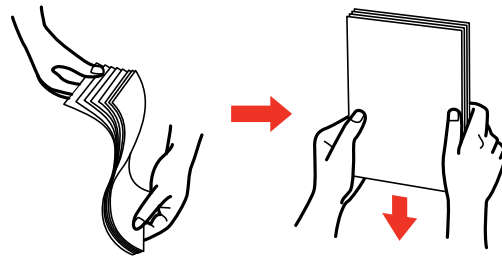

Note: Do not fan or curl photo paper.

5. Do one of the following:

- Insert paper, glossy or printable side up and short edge first, against the right side and beneath the line on the left edge guide.

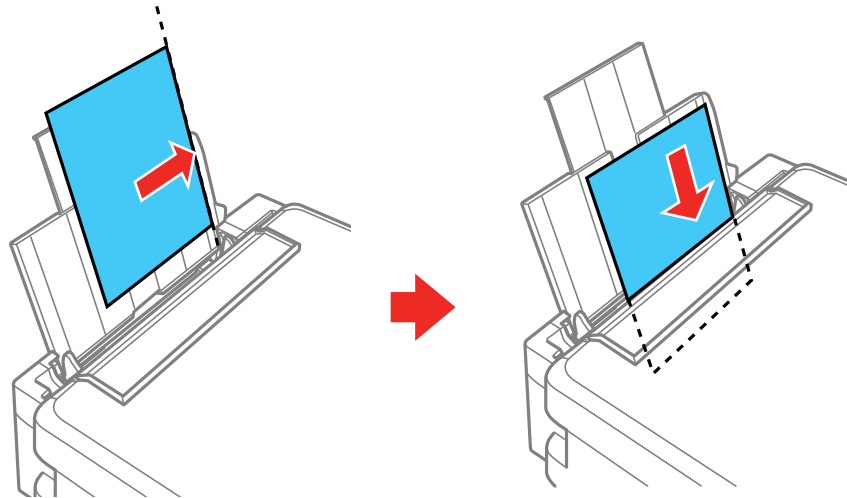

- Load up to 10 envelopes against the right side. Load them printable side up and flap edge left.

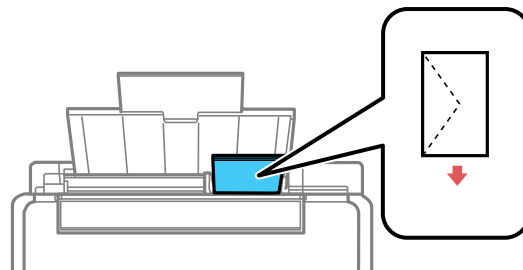

- Load a sheet of loose-leaf or other paper with holes facing as shown.

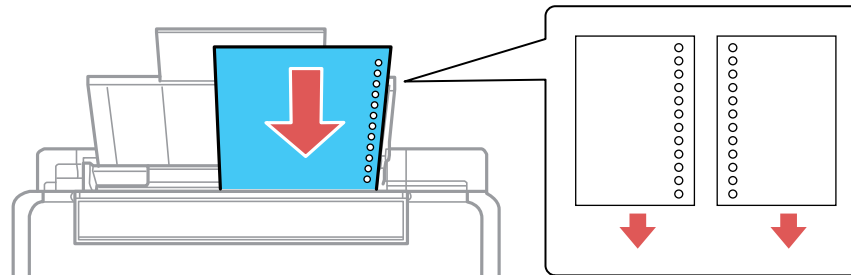

6. Slide the edge guide against the paper, but not too tightly. Then, flip the feeder guard back.

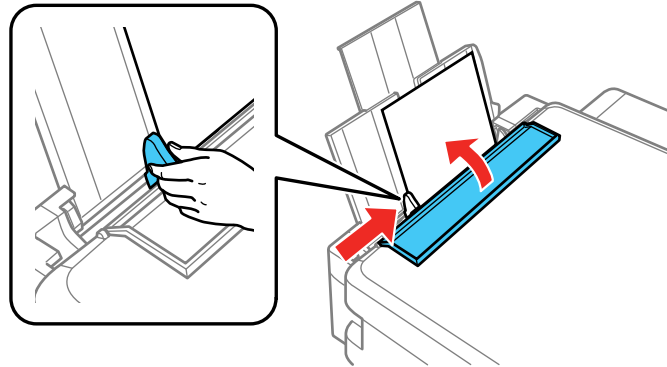

Always follow these paper loading guidelines:

- Load only the recommended number of sheets.
- Load paper short edge first, no matter which way your document faces.
- Load letterhead or pre-printed paper top edge first.
- Do not load paper above the arrow mark inside the edge guide.
- If you have trouble loading a stack of envelopes, press each envelope flat before loading it or load one envelope at a time.
- Do not load envelopes that are curled, folded, or too thin, or that have plastic windows.
- Check the paper package for any additional loading instructions.

- If you use paper with binder holes, load only one sheet at a time and use only these sizes: Letter (8.5 × 11 inches [216 × 279 mm]), A4 (8.3 × 11.7 inches [210 × 297 mm]), or Legal (8.5 × 14 inches [216 × 356 mm]).

Parent topic: [Loading Paper](#)

Related references

[Paper Loading Capacity](#)

[Paper Specifications](#)

Paper Loading Capacity

Paper type	Paper size	Load up to this many sheets
Plain paper*	Letter (8.5 × 11 inches [216 × 279 mm])	Up to the arrow mark on the edge guide
	A4 (8.3 × 11.7 inches [210 × 297 mm])	
	A6 (4.1 × 5.8 inches [105 × 148 mm])	
	Half Letter (5.5 × 8.5 inches [140 × 216 mm])	
	Legal (8.5 × 14 inches [216 × 356 mm])	1 sheet
Epson Bright White Paper*	Letter (8.5 × 11 inches [216 × 279 mm])	80 sheets
Epson Premium Photo Paper Glossy	Letter (8.5 × 11 inches [216 × 279 mm])	20 sheets
	8 × 10 inches (203 × 254 mm)	
	5 × 7 inches (127 × 178 mm)	
	4 × 6 inches (102 × 152 mm)	
Epson Presentation Paper Matte	Letter (8.5 × 11 inches [216 × 279 mm])	80 sheets

Paper type	Paper size	Load up to this many sheets
Epson Premium Presentation Paper Matte	Letter (8.5 × 11 inches [216 × 279 mm])	20 sheets
	8 × 10 inches (203 × 254 mm)	
Envelopes	No. 10 (4.1 × 9.5 inches [105 × 241 mm])	10 envelopes

* You can print 2-sided print jobs manually. Load up to 30 Letter (8.5 × 11 inches [216 × 279 mm]) or smaller sized sheets for manual 2-sided print jobs. Load 1 sheet of Legal (8.5 × 14 inches [216 × 356 mm]) sized paper for manual 2-sided print jobs.

Parent topic: [Loading Paper](#)

Available Epson Papers

You can purchase genuine Epson ink and paper at epson.com/ink3 (U.S. sales) or epson.ca (Canadian sales). You can also purchase supplies from an Epson authorized reseller. To find the nearest one, call 800-GO-EPSON (800-463-7766).

Note: Paper/media availability varies by country.

Paper Type	Size	Part number	Sheet count
Epson Bright White Paper	Letter (8.5 × 11 inches [216 × 279 mm])	S041586	500
Epson Premium Presentation Paper Matte	8 × 10 inches (203 × 254 mm)	S041467	50
	Letter (8.5 × 11 inches [216 × 279 mm])	S041257 S042180	50 100
Epson Presentation Paper Matte	Letter (8.5 × 11 inches [216 × 279 mm])	S041062	100
	Legal (8.5 × 14 inches [216 × 356 mm])	S041067	100

Paper Type	Size	Part number	Sheet count
Epson Premium Photo Paper Glossy	4 × 6 inches (102 × 152 mm)	S041808	40
		S041727	100
	5 × 7 inches (127 × 178 mm)	S041464	20
	8 × 10 inches (203 × 254 mm)	S041465	20
	Letter (8.5 × 11 inches [216 × 279 mm])	S042183	25
		S041667	50

Parent topic: [Loading Paper](#)

Paper or Media Type Settings - Product Software

For this paper	Select this Paper Type or Media Type setting
Plain paper Epson Bright White Paper	Plain Paper/Bright White Paper
Epson Premium Photo Paper Glossy	Premium Photo Paper Glossy
Epson Presentation Paper Matte Epson Premium Presentation Paper Matte	Premium Presentation Paper Matte
Envelope	Envelope

Parent topic: [Loading Paper](#)

Placing Originals on the Product

Follow the instructions here to place your original documents or photos on the product.

Caution: Do not place anything on top of your product or use its cover as a writing surface to avoid damaging it.

[Placing Originals on the Scanner Glass](#)

Placing Originals on the Scanner Glass

You can place originals up to this size on the scanner glass: Letter (8.5 × 11 inches [216 × 279 mm]) or A4 (8.3 × 11.7 inches [210 × 297 mm]).

1. Open the document cover.

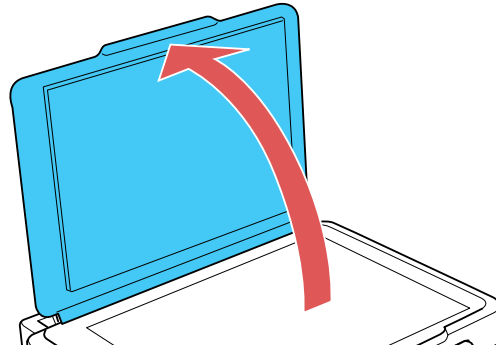

2. Place your original facedown on the scanner glass with the top facing into the corner. Slide the original to the edges of the indicated corner.

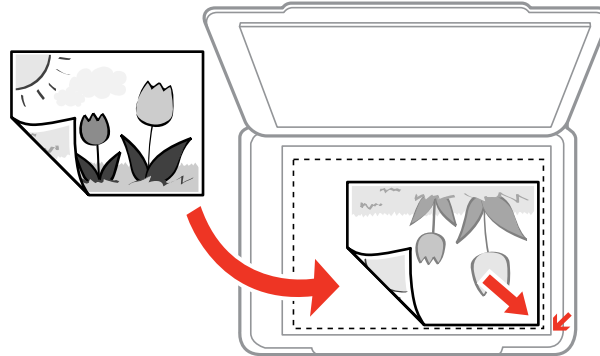

Note: You can place multiple originals on the scanner glass. Just make sure they are at least 0.8 inch (20 mm) away from each other.

Note: The edges of your original may be cropped by 0.06 inch (1.5 mm) from the edge of the scanner glass. If you are scanning in Full Auto mode or using thumbnail preview in another mode in Epson Scan, the edges of your original may be cropped by about 0.2 inch (4.5 mm) from the top and side edges. Manually position your original away from the edges to prevent cropping.

3. Close the document cover gently to keep your original in place.

Parent topic: [Placing Originals on the Product](#)

Related topics

[Copying](#)

[Scanning](#)

Copying









See the information here to copy documents or photos using your product.

Note: Copies may not be exactly the same size as your originals.

[Copying Documents or Photos](#)

Copying Documents or Photos

You can copy color or black-and-white documents or photos onto plain paper.

1. Place your original document or photo on the product.
2. Load plain paper in the product.
3. Do one of the following to start copying:
 - To copy a black-and-white original, press the  B&W copy button.
 - To copy a color original, press the  color copy button.
 - To copy a black-and-white or color original in draft mode, hold the  B&W copy button or the  color copy button for 3 seconds.
 - To make 20 black-and-white or color copies, hold the  B&W copy button or the  color copy button and press the  stop button within 3 seconds.
 - To make more than one copy, repeatedly press the  B&W copy button or the  color copy button for the number of copies you need (up to 20 copies). For example, to make 4 copies, press the button four times. Make sure you press the button in intervals of less than one second.

The product scans and prints your copy.

Note: To cancel copying, press the  stop button.

Parent topic: [Copying](#)

Related tasks

[Placing Originals on the Scanner Glass](#)

[Loading Paper in the Sheet Feeder](#)

Printing from a Computer

Before printing from your computer, make sure you have set up your product and installed its software as described on the *Start Here* sheet.

Note: If you have an Internet connection, it is a good idea to check for updates to your product software on Epson's support website. If you see a Software Update screen, select **Enable automatic checking** and click **OK**. The update scans your system to see if you have the latest product software. Follow the on-screen instructions.

[Printing with Windows](#)

[Printing with OS X](#)

[Cancelling Printing Using a Product Button](#)

Printing with Windows

You can print with your product using any Windows application, as described in these sections.

[Selecting Basic Print Settings - Windows](#)

[Selecting Double-sided Printing Settings - Windows](#)

[Selecting Additional Layout and Print Options - Windows](#)

[Selecting a Printing Preset - Windows](#)

[Selecting Extended Settings - Windows](#)

[Printing Your Document or Photo - Windows](#)

[Selecting Default Print Settings - Windows](#)

[Changing Automatic Update Options](#)

Parent topic: [Printing from a Computer](#)

Selecting Basic Print Settings - Windows

Select the basic settings for the document or photo you want to print.

1. Open a photo or document for printing.
2. Select the print command in your application.

Note: You may need to select a print icon on your screen, the **Print** option in the **File** menu, or another command. See your application's help utility for details.

3. If necessary, select your product name as the printer you want to use.

Note: You may also need to select **Properties** or **Preferences** to view your print settings.

You see the Main tab of your printer settings window:

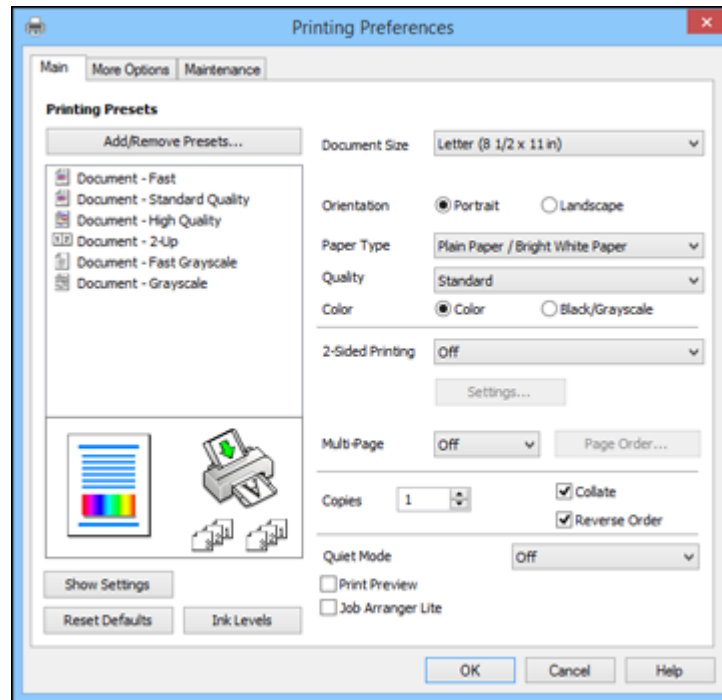

4. Select the size of the paper you loaded as the **Document Size** setting.

Note: You can also select the **User-Defined** setting to create a custom paper size.

5. Select the orientation of your document.

Note: If you are printing an envelope, select **Landscape**.

6. Select the type of paper you loaded as the **Paper Type** setting.

Note: The setting may not exactly match the name of your paper. Check the paper type settings list for details.

7. Select the **Quality** setting that matches the print quality you want to use.
8. Select a Color option:
 - To print a color document or photo, select the **Color** setting.
 - To print text and graphics in black or shades of gray, select the **Black/Grayscale** setting.
9. To print on both sides of the paper, select a **2-Sided Printing** option.
10. To print multiple pages on one sheet of paper, or print one image on multiple sheets of paper, select one of the settings in the **Multi-Page** menu and select the printing options you want.
11. To print multiple copies and arrange their print order, select the **Copies** options.
12. To reduce noise during printing when you select **Plain Paper/Bright White Paper**, select **Quiet Mode** (printing will be slower).
13. To preview your job before printing, select **Print Preview**.
14. To save your print job as a project that can be modified and combined with other print jobs, select **Job Arranger Lite**.

[Print Quality Options - Windows](#)

[Multi-Page Printing Options - Windows](#)

Parent topic: [Printing with Windows](#)

Related references

[Paper or Media Type Settings - Product Software](#)

Related tasks

[Selecting Double-sided Printing Settings - Windows](#)

Print Quality Options - Windows

You can select any of the available Quality options to fine-tune the quality of your print. Some settings may be unavailable, depending on the paper type setting you have chosen.

Draft

For draft printing on plain paper.

Standard

For everyday text and image printing.

High

For text and graphics with high print quality.

More Settings

Opens a window that lets you choose among levels of speed and quality.

Parent topic: [Selecting Basic Print Settings - Windows](#)

Multi-Page Printing Options - Windows

You can select any of the available options in the Multi-Page menu to set up your multi-page print job.

2-Up and 4-Up

Prints 2 or 4 pages on one sheet of paper. Click the **Page Order** button to select page layout and border options.

2×1 Poster, 2×2 Poster, 3×3 Poster, 4×4 Poster

Prints one image on multiple sheets of paper to create a larger poster. Click the **Settings** button to select image layout and guideline options.

Parent topic: [Selecting Basic Print Settings - Windows](#)

Selecting Double-sided Printing Settings - Windows

You can print on both sides of the paper by selecting one of the **2-Sided Printing** options on the Main tab.

Note: You will need to print one side and flip the paper over manually to print the other side.

Note: Some options may be pre-selected or unavailable, depending on other settings you have chosen or if you are accessing the product over a network.

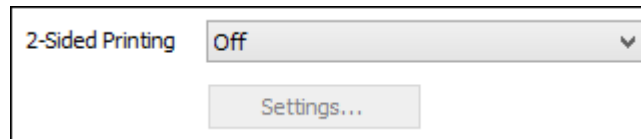

1. Select one of the following options for **2-Sided Printing**:
 - **Manual (Long-edge binding)** to print your double-sided print job by printing one side and prompting you to flip the paper over on the long edge to print the other side.
 - **Manual (Short-edge binding)** to print your double-sided print job by printing one side and prompting you to flip the paper over on the short edge to print the other side.

2. Click the **Settings** button.
You see a window like this:

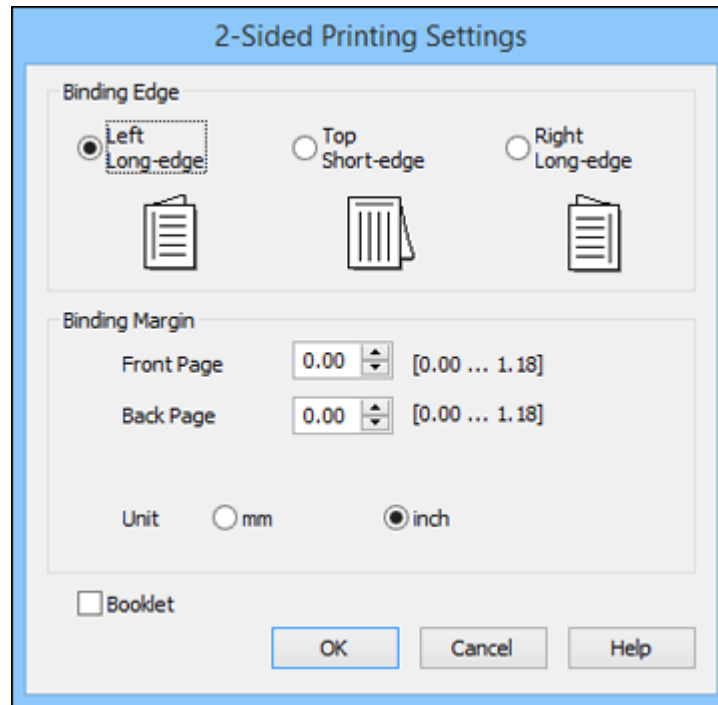

3. Select the double-sided printing options you want to use.
4. Click **OK** to return to the Main tab.
5. Print a test copy of your double-sided document to test the selected settings.
6. Follow any instructions displayed on the screen during printing.

Note: The surface of the paper may smear during double-sided printing. Make sure the ink has dried before reloading the paper.

[Double-sided Printing Options - Windows](#)

Parent topic: [Printing with Windows](#)

Related tasks

[Selecting Basic Print Settings - Windows](#)

Double-sided Printing Options - Windows

You can select any of the available options on the 2-Sided Printing Settings window to set up your double-sided print job.

Binding Edge Options

Select a setting that orients double-sided print binding in the desired direction.

Binding Margin Options

Select options that define a wider margin to allow for binding.

Booklet

Select the **Booklet** checkbox to print double-sided pages as a booklet.

Parent topic: [Selecting Double-sided Printing Settings - Windows](#)

Selecting Additional Layout and Print Options - Windows

You can select a variety of additional layout and printing options for your document or photo on the More Options tab.

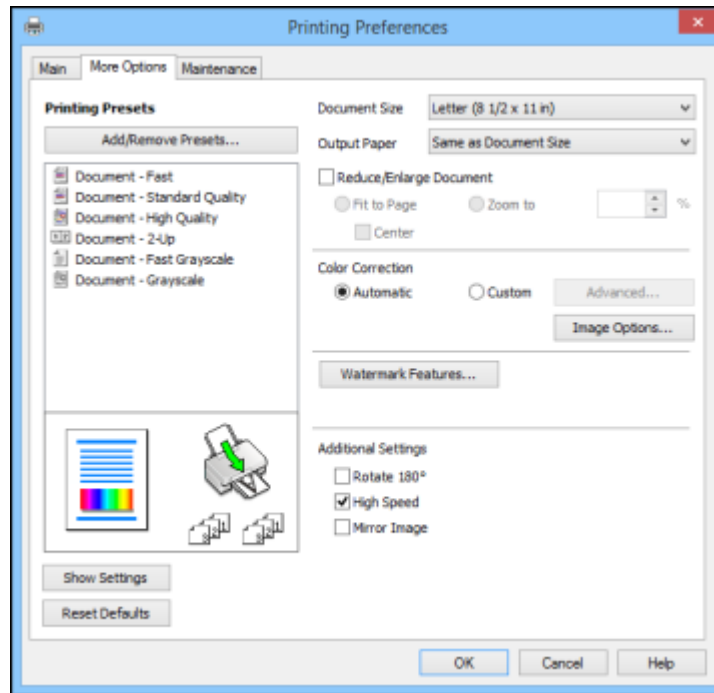

1. To change the size of your printed document or photo, select the **Reduce/Enlarge Document** checkbox and select one of these sizing options:
 - Select the **Fit to Page** option to size your image to fit the paper you loaded. Select the size of the your document or photo as the **Document Size** setting, and the size of your paper as the **Output Paper** setting. If you want to center your image on the paper, select the **Center** option.
 - Select the **Zoom to** option to reduce or enlarge your document or photo by a specific percentage. Select the percentage in the % menu.
2. Select one of the following Color Correction options:
 - Select **Automatic** to automatically adjust the sharpness, brightness, contrast, and color saturation for your image.

- Select **Custom** and click the **Advanced** button to manually adjust the color correction settings or turn off color management in your printer software.
 - Select **Image Options** to access additional settings for improving printed images.
3. To add the following features, click the **Watermark Features** button:
- **Watermark**: adds a visible watermark to your printout.

Note: Click the **Add/Delete** button to create your own watermark, and click the **Settings** button to customize the watermark.

- **Header/Footer**: adds information such as the date and time to the top or bottom of your printout.

Note: Click the **Settings** button to customize the text and location of the header or footer.

4. Select any of the Additional Settings options to customize your print.

[Custom Color Correction Options - Windows](#)

[Image Options and Additional Settings - Windows](#)

[Header/Footer Settings - Windows](#)

Parent topic: [Printing with Windows](#)

Custom Color Correction Options - Windows

You can select any of the available options in the Color Correction window to customize the image colors for your print job.

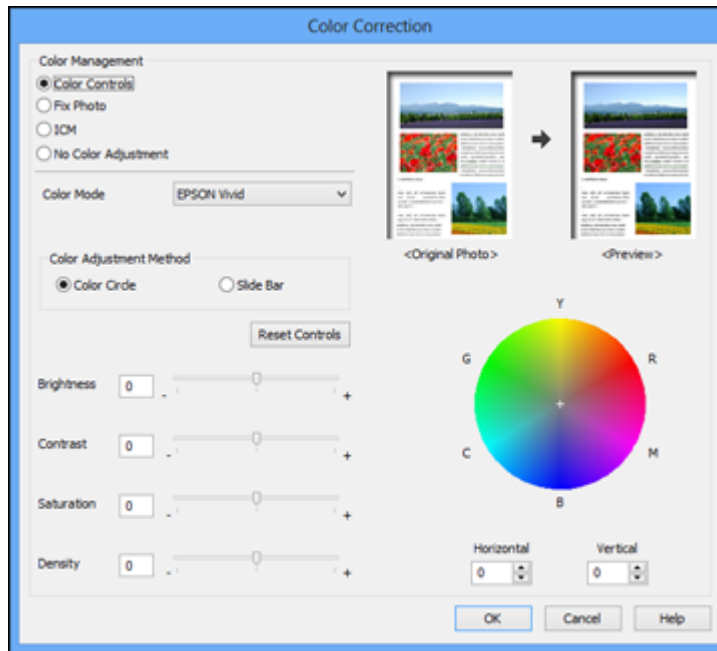

Color Controls

Lets you select a **Color Mode** setting, individual settings for **Brightness**, **Contrast**, **Saturation**, and **Density**, and individual color tones. Depending on the selected color mode, you can also adjust the midtone density using the **Gamma** setting.

Fix Photo

Improves the color, contrast, and sharpness of flawed photos.

Note: Fix Photo uses a sophisticated face recognition technology to optimize photos that include faces. For this to work, both eyes and the nose must be visible in the subject's face. If your photo includes a face with an intentional color cast, such as a statue, you may want to turn off **Fix Photo** to retain the special color effects.

ICM

Lets you manage color using installed color printing profiles.

No Color Adjustment

Turns off color management in your printer software so you can manage color using only your application software.

Parent topic: [Selecting Additional Layout and Print Options - Windows](#)

Image Options and Additional Settings - Windows

You can select any of the Image Options and Additional Settings to customize your print. Some options may be pre-selected or unavailable, depending on other settings you have chosen.

Image Options**Emphasize Text**

Adjusts the weight of printed text to increase readability.

Emphasize Thin Lines

Adjusts the weight of printed lines to increase visibility.

Edge Smoothing

Smooths jagged edges in low-resolution images such as screen captures or images from the Web.

Fix Red-Eye

Reduces or removes red-eye in photos.

Additional Settings Options**Rotate 180°**

Prints the image rotated 180° from its original orientation.

High Speed

Speeds up printing but may reduce print quality.

Mirror Image

Flips the printed image left to right.

Parent topic: [Selecting Additional Layout and Print Options - Windows](#)

Header/Footer Settings - Windows

You can select any of the Header/Footer Settings options to add headers or footers when you print. The items are available to print at the top or bottom of your pages, in either the left, right, or center of the page.

Note: These settings are not saved with your document.

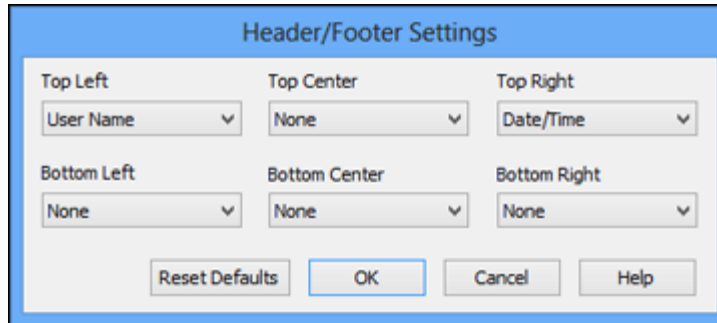

You can select to print the following information:

- User Name
- Computer Name
- Date
- Date/Time
- Collate Number (copy number)

Note: The user name, computer name, date, and time come from the Windows Control Panel on your computer.

Parent topic: [Selecting Additional Layout and Print Options - Windows](#)

Selecting a Printing Preset - Windows

For quick access to common groups of print settings, you can select a printing preset on the Main or More Options tab.

Note: You can create your own preset by clicking the **Add/Remove Presets** button.

1. Click the **Main** or **More Options** tab.

You see the available **Printing Presets** on the left:

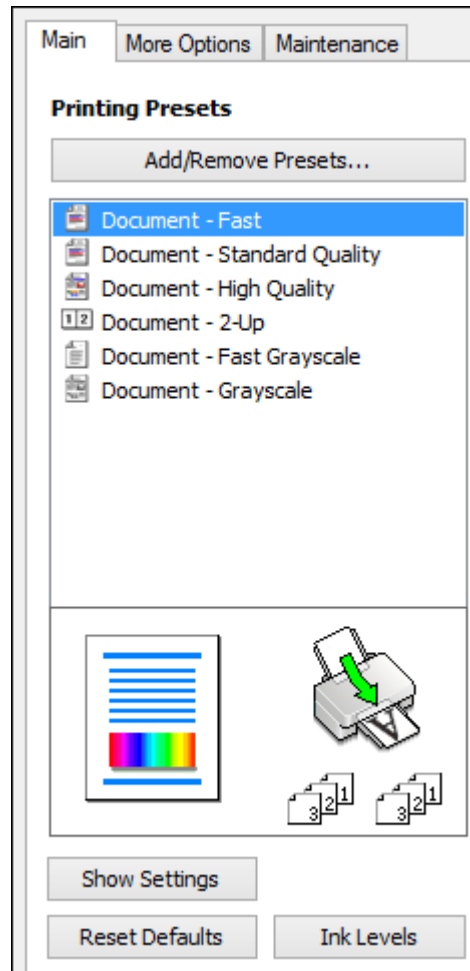

2. Place your cursor over one of the **Printing Presets** to view its list of settings.
3. Click on a preset to change its settings, or use any of the available options on the screen to control your printing presets.
4. To choose a preset for printing, select it.
5. Click **OK**.

Parent topic: [Printing with Windows](#)

Selecting Extended Settings - Windows

You can select additional settings that apply to all the print jobs you send to your product.

1. Access the Windows Desktop and right-click the product icon in the Windows taskbar.
2. Select **Printer Settings**.
3. Click the **Maintenance** tab.

You see the maintenance options:

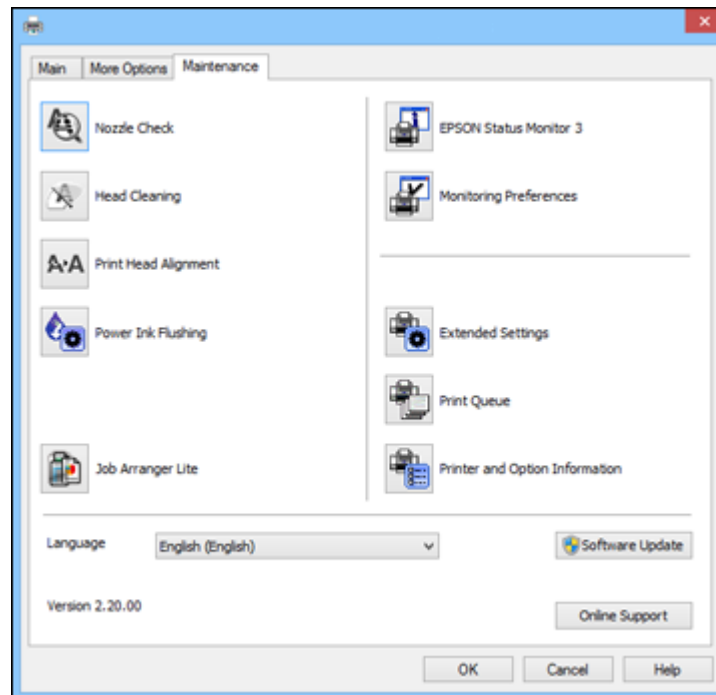

4. Click the **Extended Settings** button.

You see this window:

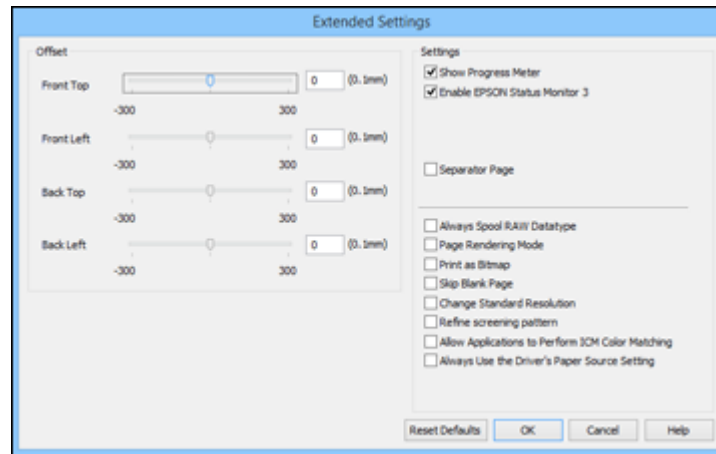

5. Select any of the extended settings to customize your print.
6. Click **OK** to close the Extended Settings window.
7. Click **OK** to close the printer software window.

[Extended Settings - Windows](#)

Parent topic: [Printing with Windows](#)

Extended Settings - Windows

You can select from these settings on the Extended Settings window.

Show Progress Meter

Displays the progress of print jobs as they are being printed.

Enable EPSON Status Monitor 3

Enables product monitoring for ink and paper supplies and other issues.

Separator Page

Before each document, prints a separator page containing the title, user, date, and time.

Always Spool RAW Datatype

Increases print speed and may solve other printing problems.

Page Rendering Mode

Increases print speed when printing is extremely slow or the print head stops during printing.

Print as Bitmap

Increases print speed when printing is extremely slow or the print head stops during printing, and other settings do not help.

Skip Blank Page

Ensures that your product does not print pages that contain no text or images.

Change Standard Resolution

Reduces the resolution of print data to correct printing problems.

Refine screening pattern

Prints graphics with a finer screening pattern.

Allow Applications to Perform ICM Color Matching

Allows applications to perform ICM color matching.

Always Use the Driver's Paper Source Setting

Prints using the paper source setting in the printer driver, rather than the setting in your application.

Parent topic: [Selecting Extended Settings - Windows](#)

Printing Your Document or Photo - Windows

Once you have selected your print settings, you are ready to save your settings and print.

1. Click **OK** to save your settings.

You see your application's Print window, such as this one:

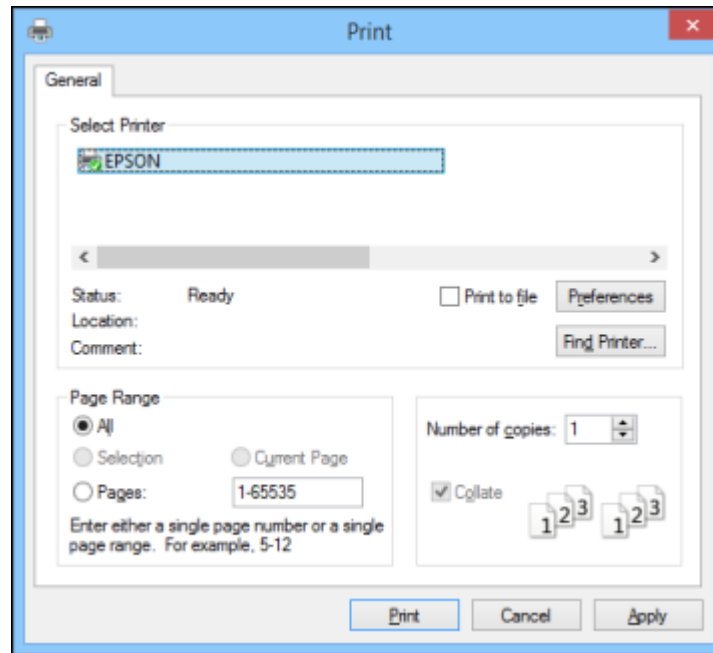

2. Click **OK** or **Print** to start printing.

[Checking Print Status - Windows](#)

Parent topic: [Printing with Windows](#)

Checking Print Status - Windows

During printing, you see this window showing the progress of your print job. It allows you to control printing and check ink status.

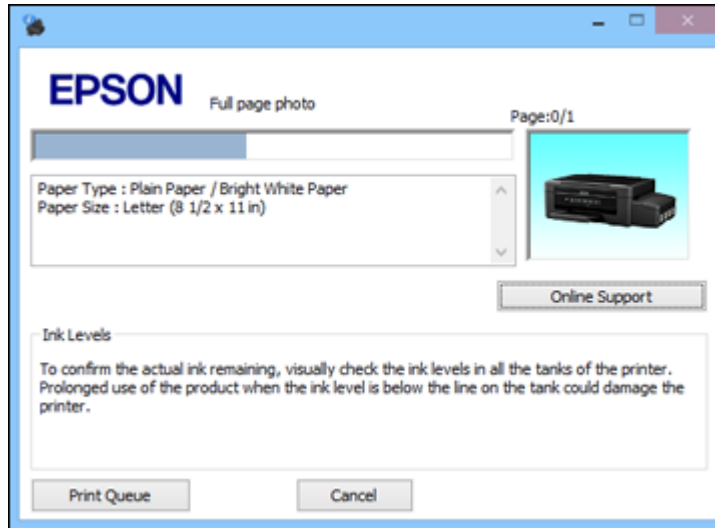

- To cancel printing, click **Cancel**.
- To see print jobs lined up for printing, click **Print Queue**.

Parent topic: [Printing Your Document or Photo - Windows](#)

Selecting Default Print Settings - Windows

When you change your print settings in a program, the changes apply only while you are printing in that program session. If you want to change the print settings you use in all your Windows programs, you can select new default print settings.

1. Access the Windows Desktop and right-click the product icon in the Windows taskbar.
2. Select **Printer Settings**.

You see the printer settings window:

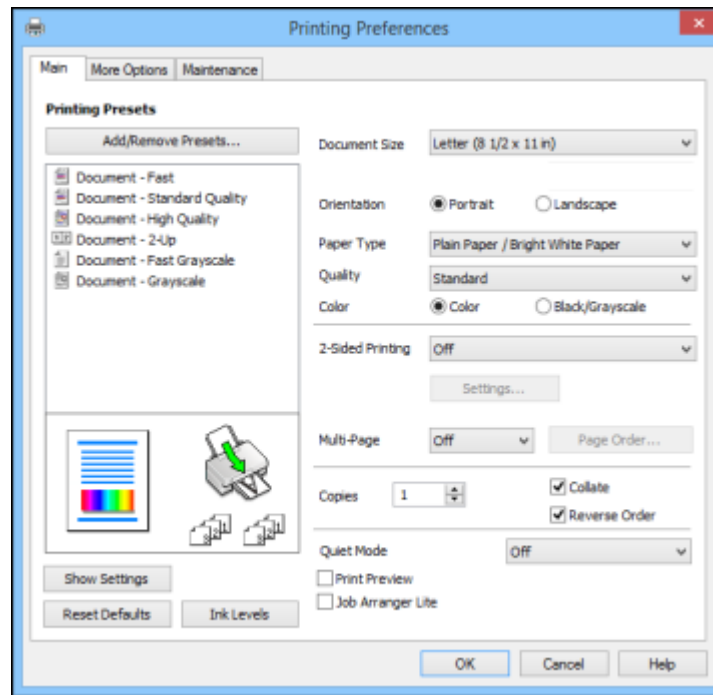

3. Select the print settings you want to use as defaults in all your Windows programs.
4. Click **OK**.

These settings are now the defaults selected for printing. You can still change them as needed for printing in any program session.

[Changing the Language of the Printer Software Screens](#)

Parent topic: [Printing with Windows](#)

Changing the Language of the Printer Software Screens

You can change the language used on the Windows printer software screens.

1. Access the Windows Desktop and right-click the product icon in the Windows taskbar.
2. Select **Printer Settings**.

You see the printer settings window.

3. Click the **Maintenance** tab.
You see the maintenance options:

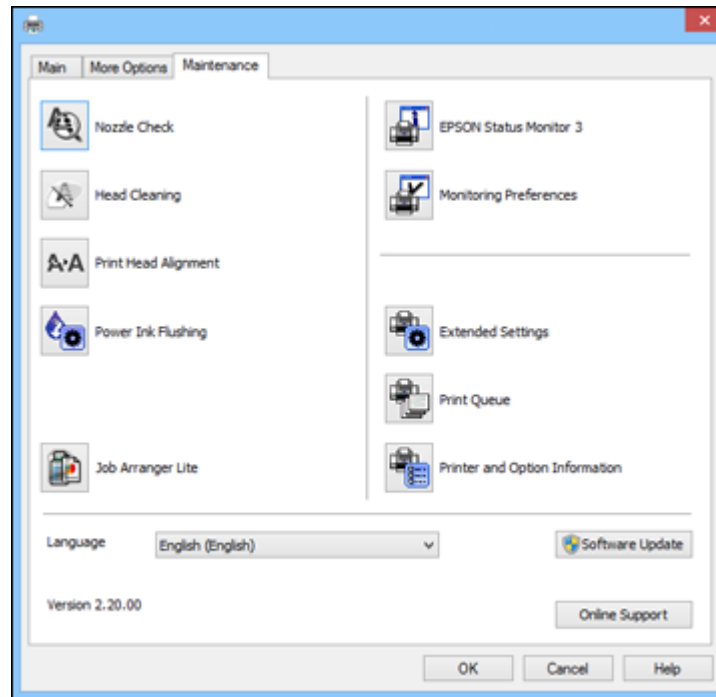

4. Select the language you want to use as the **Language** setting.
5. Click **OK** to close the printer software window.

The printer software screens appear in the language you selected the next time you access them.

Parent topic: [Selecting Default Print Settings - Windows](#)

Changing Automatic Update Options

Your printer software for Windows automatically checks for updates to the product software. You can change how often the software checks for updates or disable this feature.

1. Access the Windows Desktop and right-click the product icon in the Windows taskbar.
2. Select **Software Update Settings**.

You see this window:

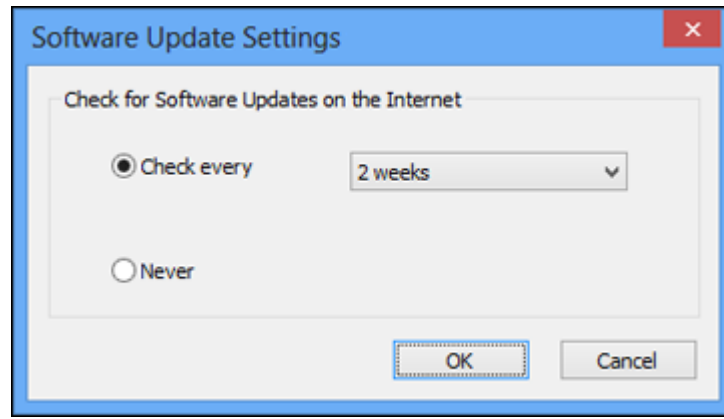

3. Do one of the following:
 - To change how often the software checks for updates, select a setting in the **Check every** menu.
 - To disable the automatic update feature, select the **Never** option.
4. Click **OK** to exit.

Note: If you choose to disable the automatic update feature, you can check for updates manually.

Parent topic: [Printing with Windows](#)

Related tasks

[Checking for Software Updates](#)

Printing with OS X

You can print with your product using any OS X printing program, as described in these sections.

Note: If you have an Internet connection, it is a good idea to check for updates to your product software on Epson's support website.

[Selecting Basic Print Settings - OS X](#)

[Selecting Page Setup Settings - OS X](#)

[Selecting Print Layout Options - OS X](#)

[Sizing Printed Images - OS X](#)

[Managing Color - OS X](#)

[Selecting Printing Preferences - OS X](#)

[Printing Your Document or Photo - OS X](#)

Parent topic: [Printing from a Computer](#)

Selecting Basic Print Settings - OS X

Select the basic settings for the document or photo you want to print.

1. Open a photo or document for printing.
2. Select the print command in your application.

Note: You may need to select a print icon on your screen, the **Print** option in the File menu, or another command. See your application's help utility for details.

3. Select your product as the **Printer** setting.

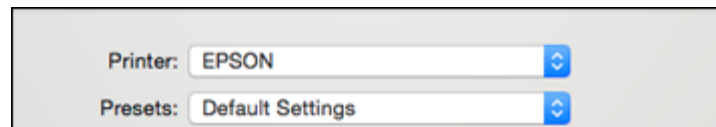

4. If necessary, click the arrow next to the Printer setting or the **Show Details** button to expand the print window.

You see the expanded printer settings window for your product:

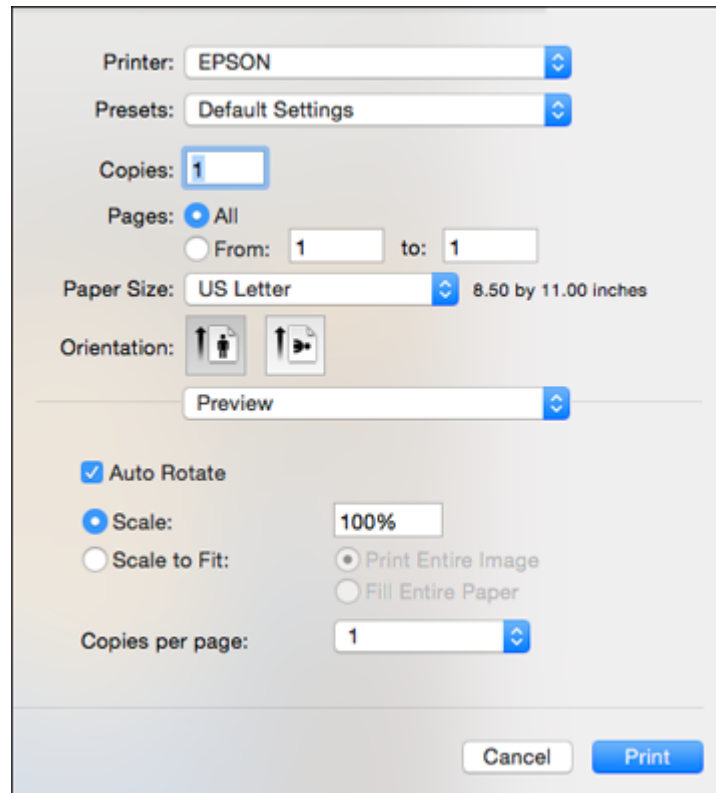

Note: The print window may look different, depending on the version of OS X and the application you are using.

5. Select the **Copies** and **Pages** settings as necessary.

Note: If you do not see these settings in the print window, check for them in your application before printing.

6. Select the page setup options: **Paper Size** and **Orientation**.

Note: If you do not see these settings in the print window, check for them in your application before printing. They may be accessible by selecting **Page Setup** from the File menu.

7. Select any application-specific settings that appear on the screen, such as those shown in the image above for the Preview application.
8. Select **Print Settings** from the pop-up menu.

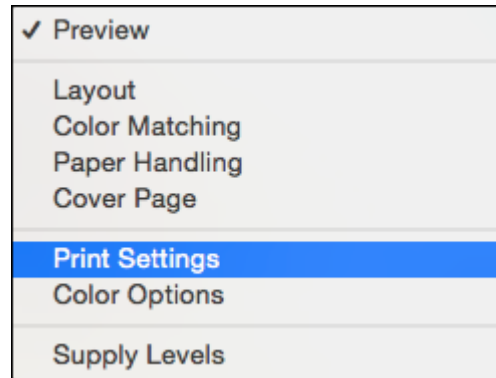

You see these settings:

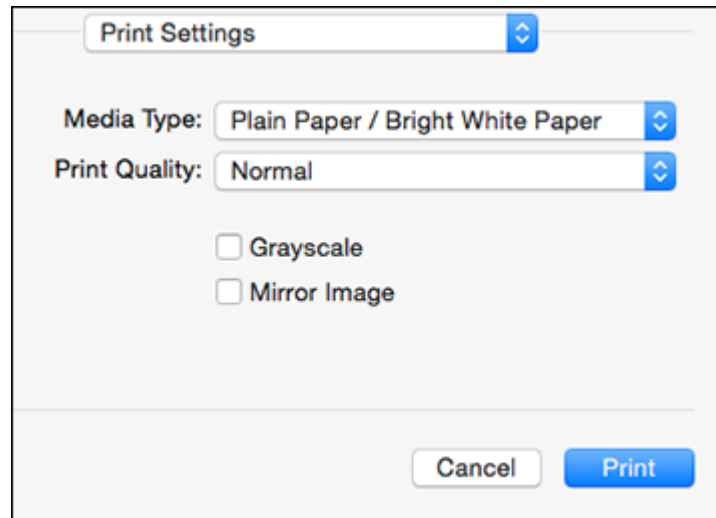

9. Select the type of paper you loaded as the **Media Type** setting.

Note: The setting may not exactly match the name of your paper. Check the paper type settings list for details.

10. Select the **Print Quality** setting you want to use.
11. Select any of the available print options.

[Print Quality Options - Mac OS X](#)

[Print Options - OS X](#)

Parent topic: [Printing with OS X](#)

Related references

[Paper or Media Type Settings - Product Software](#)

Related tasks

[Selecting Page Setup Settings - OS X](#)

Print Quality Options - Mac OS X

You can select any of the available Print Quality options to fine-tune the quality of your print. Some settings may be unavailable, depending on the paper type and border setting you have chosen.

Fast Economy

For the fastest printing with draft quality.

Economy

For fast printing with reduced quality.

Normal

For everyday text and image printing.

Fine

For text and graphics with good quality and print speed.

Quality

For photos and graphics with good quality and print speed.

High Quality

For photos and graphics with high print quality.

Parent topic: [Selecting Basic Print Settings - OS X](#)

Print Options - OS X

You can select any of the print options to customize your print. Some options may be unavailable, depending on other settings you have chosen.

Grayscale

Prints text and graphics in black or shades of gray.

Mirror Image

Lets you flip the printed image horizontally.

Parent topic: [Selecting Basic Print Settings - OS X](#)

Selecting Page Setup Settings - OS X

Depending on your application, you may be able to select the paper size and orientation settings from the print window.

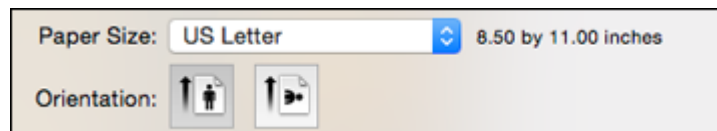

Note: If you do not see these settings in the print window, check for them in your application before printing. They may be accessible by selecting **Page Setup** from the File menu.

1. Select the size of the paper you loaded as the **Paper Size** setting. You can also select a custom setting to create a custom paper size.
2. Select the orientation of your document or photo as shown in the print window.

Note: If you are printing an envelope, select the  icon.

Note: You can reduce or enlarge the size of the printed image by selecting **Paper Handling** from the pop-up menu and selecting a scaling option.

Parent topic: [Printing with OS X](#)

Selecting Print Layout Options - OS X

You can select a variety of layout options for your document or photo by selecting **Layout** from the pop-up menu on the print window.

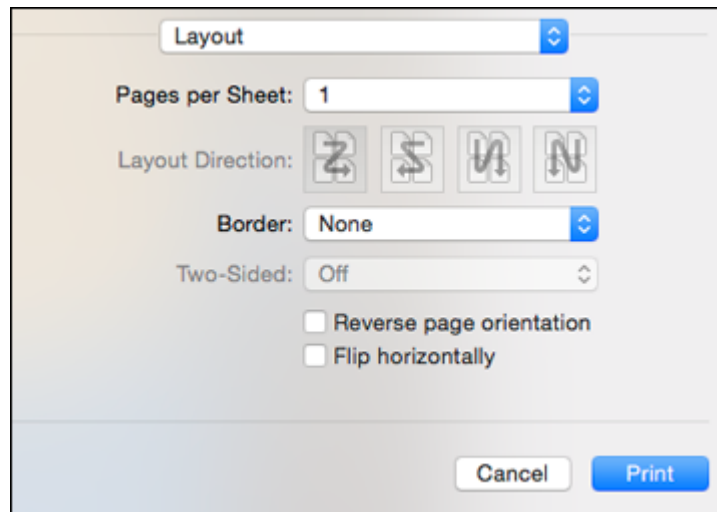

- To print multiple pages on one sheet of paper, select the number of pages in the **Pages per Sheet** pop-up menu. To arrange the print order of the pages, select a **Layout Direction** setting.

- To print borders around each page on the sheet, select a line setting from the **Border** pop-up menu.
- To invert or flip the printed image, select the **Reverse page orientation** or **Flip horizontally** settings.

Parent topic: [Printing with OS X](#)

Sizing Printed Images - OS X

You can adjust print order and the size of the image as you print it by selecting **Paper Handling** from the pop-up menu on the Print window.

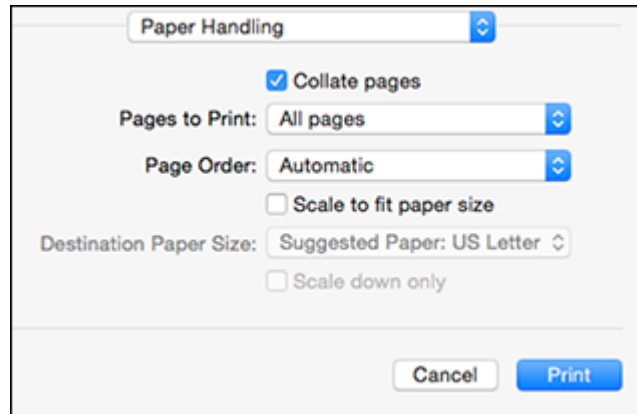

- To print only selected pages in a multi-page document, select an option from the **Pages to Print** pop-up menu.
- To adjust the order in which pages are printed, select an option from the **Page Order** pop-up menu.
- To scale the image to fit on a specific paper size, select the **Scale to fit paper size** checkbox and select a paper size from the **Destination Paper Size** pop-up menu.

Parent topic: [Printing with OS X](#)

Managing Color - OS X

You can adjust the Color Matching and Color Options settings to fine-tune the colors in your printout, or turn off color management in your printer software.

1. Select **Color Matching** from the pop-up menu in the print window.

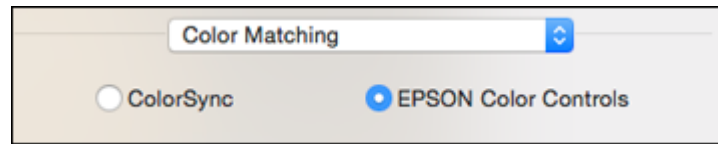

2. Select one of the available options.
3. Select **Color Options** from the pop-up menu in the print window.

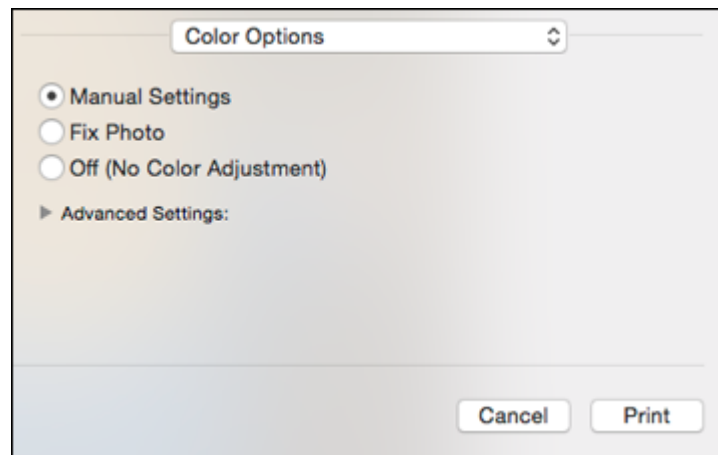

Note: The available settings on the Color Options menu depend on the option you selected on the Color Matching menu.

4. Select one of the available options.

[Color Matching and Color Options - OS X](#)

Parent topic: [Printing with OS X](#)

Color Matching and Color Options - OS X

You can select from these settings on the **Color Matching** and **Color Options** menus.

Color Matching Settings

EPSON Color Controls

Lets you manage color using controls in your printer software or turn off color management.

ColorSync

Prints using standard color profiles for your product and paper to help match image colors. You can customize the conversion method and filter settings on the ColorSync pop-up menu in the print window.

Color Options Settings

Manual Settings

Lets you select manual color adjustments. Click the arrow next to **Advanced Settings** and select settings for **Brightness**, **Contrast**, **Saturation**, and individual color tones. You can also select a color **Mode** setting for printing photos and graphics and the **Fix Red-Eye** setting to reduce or remove red-eye in photos. Depending on the selected color mode, you can also adjust the midtone density using the **Gamma** setting.

Fix Photo

Improves the color, contrast, and sharpness of flawed photos. Click the arrow next to **Advanced Settings** and select the **Fix Red-Eye** setting to reduce or remove red-eye in photos.

Note: Fix Photo uses a sophisticated face recognition technology to optimize photos that include faces. For this to work, both eyes and the nose must be visible in the subject's face. If your photo includes a face with an intentional color cast, such as a statue, you may want to turn off **Fix Photo** to retain the special color effects.

Off (No Color Adjustment)

Turns off color management in your printer software so you can manage color using only your application software.

Note: An ICC profile is required if color management is turned off.

Parent topic: [Managing Color - OS X](#)

Selecting Printing Preferences - OS X

You can select printing preferences that apply to all the print jobs you send to your product.

1. In the Apple menu or the Dock, select **System Preferences**.
2. Select **Print & Fax**, **Print & Scan**, or **Printers & Scanners**, select your product, and select **Options & Supplies**.

3. Select **Driver** or **Options**.

You see a screen like this:

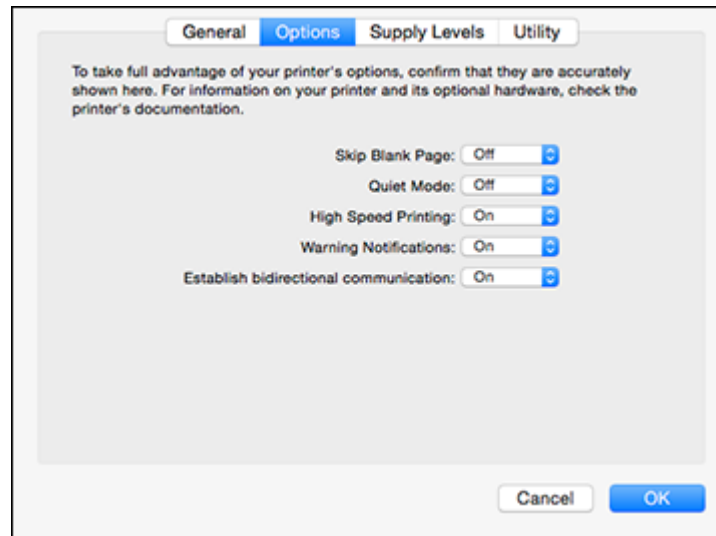

4. Select any of the available printing preferences.
5. Click **OK**.

[Printing Preferences - OS X](#)

Parent topic: [Printing with OS X](#)

Printing Preferences - OS X

You can select from these settings on the **Options** or **Driver** tab.

Skip Blank Page

Ensures that your product does not print pages that contain no text or images.

Quiet Mode

Lessens noise during printing when you select **Plain Paper/Bright White Paper** as the paper Type or Media Type setting.

High Speed Printing

Speeds up printing but may reduce print quality.

Warning Notifications

Lets you choose whether or not to receive warning notifications from the printer software for various operating conditions.

Establish bidirectional communication

Allows the product to communicate with the computer. Do not change the default setting unless you experience issues when using a shared printing pool.

Parent topic: [Selecting Printing Preferences - OS X](#)

Printing Your Document or Photo - OS X

Once you have selected your print settings, you are ready to print.

Click **Print** at the bottom of the print window.

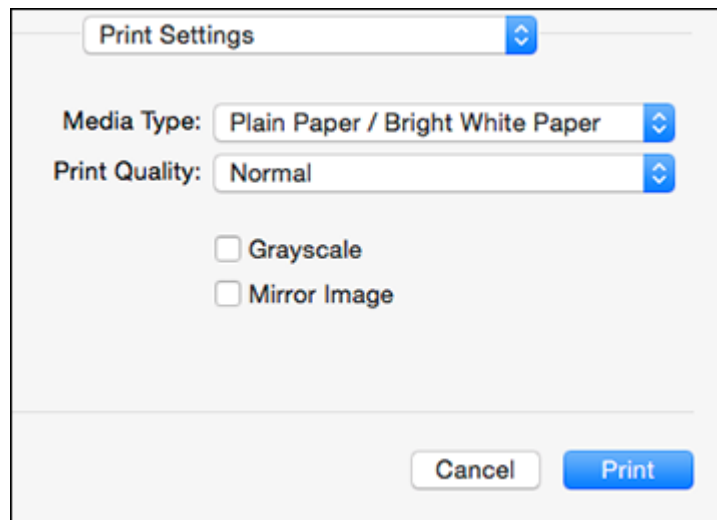

[Checking Print Status - OS X](#)

Parent topic: [Printing with OS X](#)

Checking Print Status - OS X



During printing, you can view the progress of your print job and control printing.

1. Click the printer icon when it appears in the Dock.

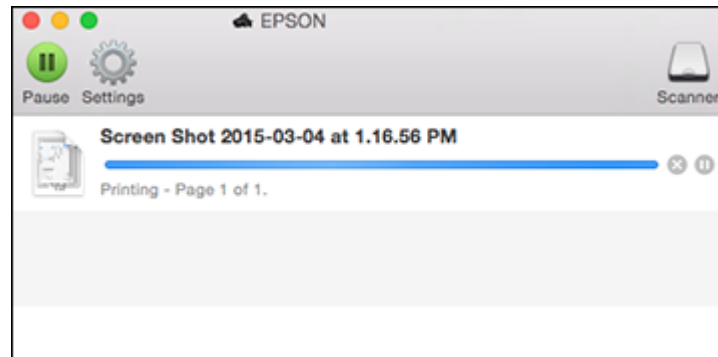
You see the print status window:



2. Select the following options as necessary:

- To cancel printing, click the print job and click  or **Delete**.
- To pause a print job, click the print job and click  or **Hold**. To resume a print job, click the paused print job and click  or **Resume**.
- To pause printing for all queued print jobs, click **Pause** or **Pause Printer**.
- To display other printer information, click **Settings**.

Parent topic: [Printing Your Document or Photo - OS X](#)

Canceling Printing Using a Product Button

If you need to cancel printing, press the  stop button on your product.

Parent topic: [Printing from a Computer](#)

Scanning

You can scan original documents or photos and save them as digital files.

[Starting a Scan](#)

[Selecting Epson Scan Settings](#)

[Scanning with OS X Using Image Capture](#)

[Scanning Special Projects](#)

Starting a Scan

After placing your original documents or photos on your product for scanning, start scanning using one of these methods.

[Starting a Scan Using the Product Buttons](#)

[Starting a Scan Using the Epson Scan Icon](#)

[Starting a Scan from a Scanning Program](#)

Parent topic: [Scanning](#)



Related tasks

[Placing Originals on the Scanner Glass](#)

Starting a Scan Using the Product Buttons

You can scan an image and save it as a PDF using your product's control panel buttons.

Note: You must connect your product with a USB cable to scan using the buttons.

1. Make sure you installed the product software and connected the product to your computer.
2. Press the  B&W copy button and the  color copy button at the same time.

Your original is scanned and saved as a PDF on your computer.

[Changing Default Scan Button Settings](#)

Parent topic: [Starting a Scan](#)

Changing Default Scan Button Settings

You can view or change the default scan settings your product uses when you scan to your computer using the product buttons. You do this using the Event Manager program.

1. Do one of the following to open Event Manager:
 - **Windows 8.x:** Navigate to the **Apps** screen and select **Event Manager**.
 - **Windows (other versions):** Click  or **Start > All Programs** or **Programs > EPSON Software > Event Manager**.
 - **OS X:** Open the **Applications** folder, click **Epson Software**, and click **Event Manager**.
2. Open the **Scanner** (Windows) or **Select Scanner** (OS X) drop-down list and select your product, if necessary.
3. Click **Make Job Settings**.
4. Open the **Edit Job Settings** drop-down list and select the scan button settings you want to view or change.
5. Change the settings as necessary.
6. Click **OK**.
7. Click **Close** to close the Event Manager window.

Parent topic: [Starting a Scan Using the Product Buttons](#)

Starting a Scan Using the Epson Scan Icon

You can start the Epson Scan program to select scan settings, scan, and save the scanned image to a file.

- **Windows 8.x:** Navigate to the **Apps** screen and select **EPSON Scan** under **EPSON** or **EPSON Software**.
- **Windows (other versions):** Click  or **Start**, and select **All Programs** or **Programs**. Select **EPSON** or **EPSON Software** and click **EPSON Scan**.
- **OS X:** Open the **Applications** folder, open the **Epson Software** folder, and double-click the **EPSON Scan** icon.

Note: With OS X, in addition to scanning with Image Capture, you can download and install Epson Scan scanning software. Epson Scan provides additional image adjustment and photo correction features for enhancing scanned images, and provides an interface for TWAIN-compliant OCR scanning software. To download Epson Scan, visit Epson's driver download site ([U.S. downloads](#) or [Canadian downloads](#)).

You see an Epson Scan window like this:

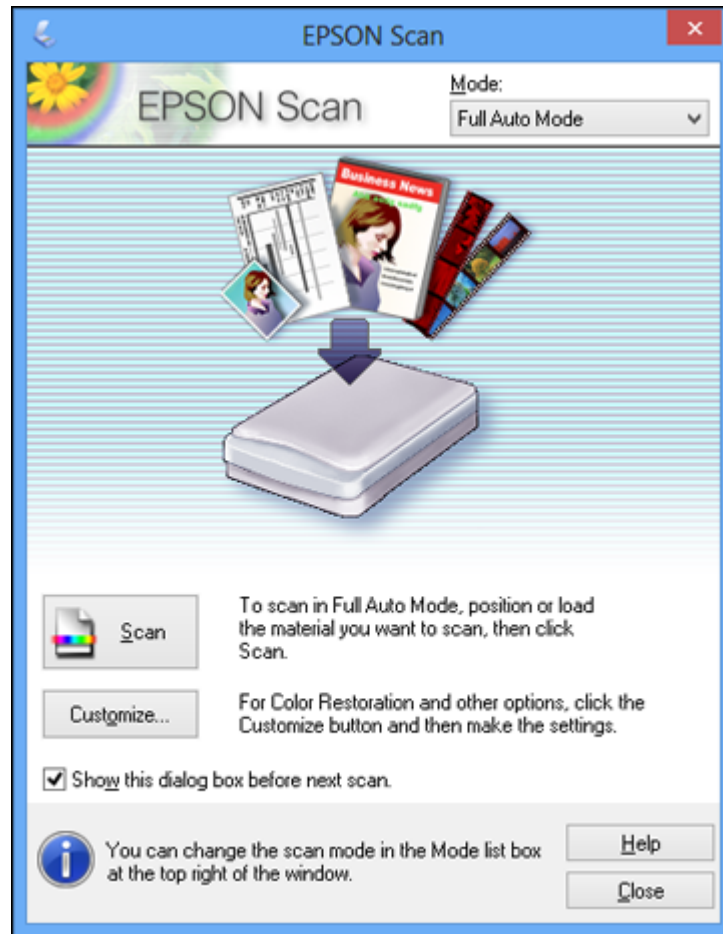

Parent topic: [Starting a Scan](#)

Related tasks

[Scanning with OS X Using Image Capture](#)

Related topics

[Selecting Epson Scan Settings](#)

Starting a Scan from a Scanning Program

You can start Epson Scan from a TWAIN-compliant scanning program to select scan settings, scan, and open the scanned image in the program.

Note: With OS X, in addition to scanning with Image Capture, you can download and install Epson Scan scanning software. Epson Scan provides additional image adjustment and photo correction features for enhancing scanned images, and provides an interface for TWAIN-compliant OCR scanning software. To download Epson Scan, visit Epson's driver download site ([U.S. downloads](#) or [Canadian downloads](#)).

1. Open your scanning program and select its scanning option. (See your scanning program help for instructions.)

2. Select your product.

Note: In certain programs, you may need to select your product as the "source" first. If you see a **Select Source** option, choose it and select your product. With Windows, do not select a **WIA** option for your product; it will not work correctly.

You see an Epson Scan window like this:

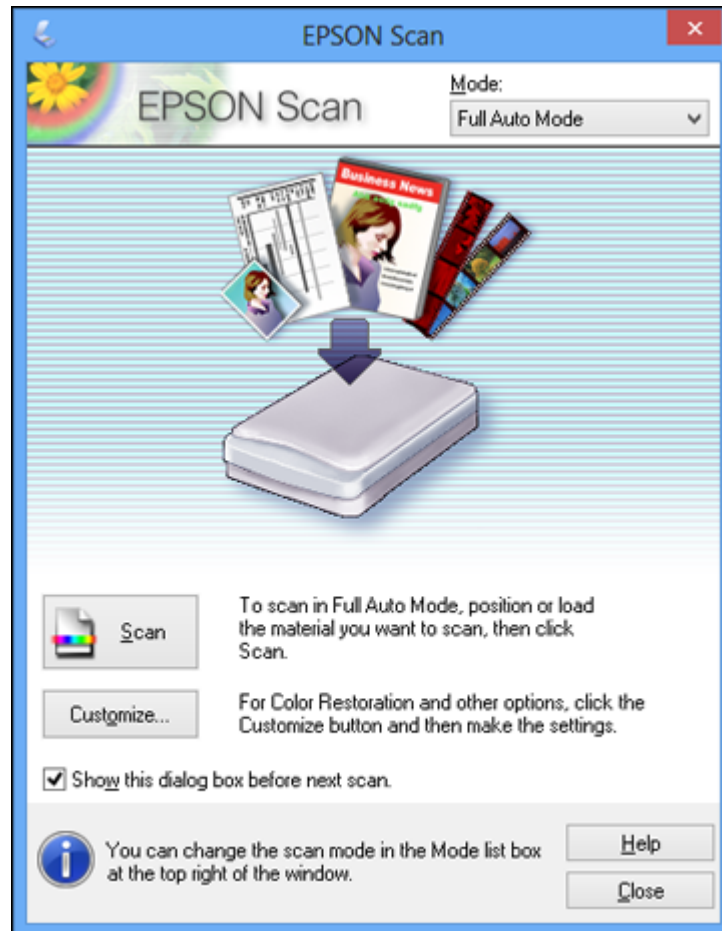

Note: In certain programs, you may see the program's scan window instead of the Epson Scan window. Select scanning options as necessary.

Parent topic: [Starting a Scan](#)

Related tasks

[Scanning with OS X Using Image Capture](#)

Related topics

[Selecting Epson Scan Settings](#)

Selecting Epson Scan Settings

After starting Epson Scan, you can select settings in various modes to customize your scan.

[Scan Modes](#)

[Selecting the Scan Mode](#)

[Scanning in Full Auto Mode](#)

[Scanning in Home Mode](#)

[Scanning in Office Mode](#)

[Scanning in Professional Mode](#)

[Image Preview Guidelines](#)

[Scan Resolution Guidelines](#)

[Selecting Scan File Settings](#)

Parent topic: [Scanning](#)

Scan Modes

Epson Scan provides a choice of scan modes with different levels of control over your settings.

Full Auto Mode

This mode automatically detects the type of content you are scanning, selects settings for it, and saves your scanned image. You can also select various image adjustment options.

Home Mode

You can select setting groups based on the type of content you are scanning. You can also select various image adjustment options, and preview and size your scanned image.

Office Mode

You can quickly scan text documents and adjust them on a preview screen. You can also select various image adjustment options and preview your scanned image.

Professional Mode

You can manually customize all available settings, and preview and size your scanned image.

Parent topic: [Selecting Epson Scan Settings](#)

Selecting the Scan Mode

Select the Epson Scan mode you want to use from the Mode box in the upper right corner of the Epson Scan window:

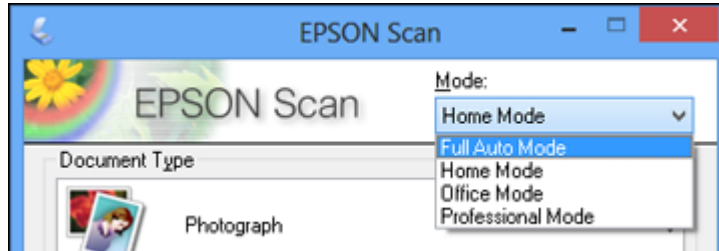

Parent topic: [Selecting Epson Scan Settings](#)

Related tasks

[Scanning in Full Auto Mode](#)

[Scanning in Home Mode](#)

[Scanning in Office Mode](#)

[Scanning in Professional Mode](#)

Scanning in Full Auto Mode

When you scan in Full Auto Mode, Epson Scan automatically saves your scanned file in JPEG format in your operating system's Pictures or My Pictures folder, or opens it in your scanning program. You can change the scanned file settings and select various image adjustment options before you scan, if necessary.

1. Start Epson Scan and select **Full Auto Mode** as the Mode setting.

You see this window:

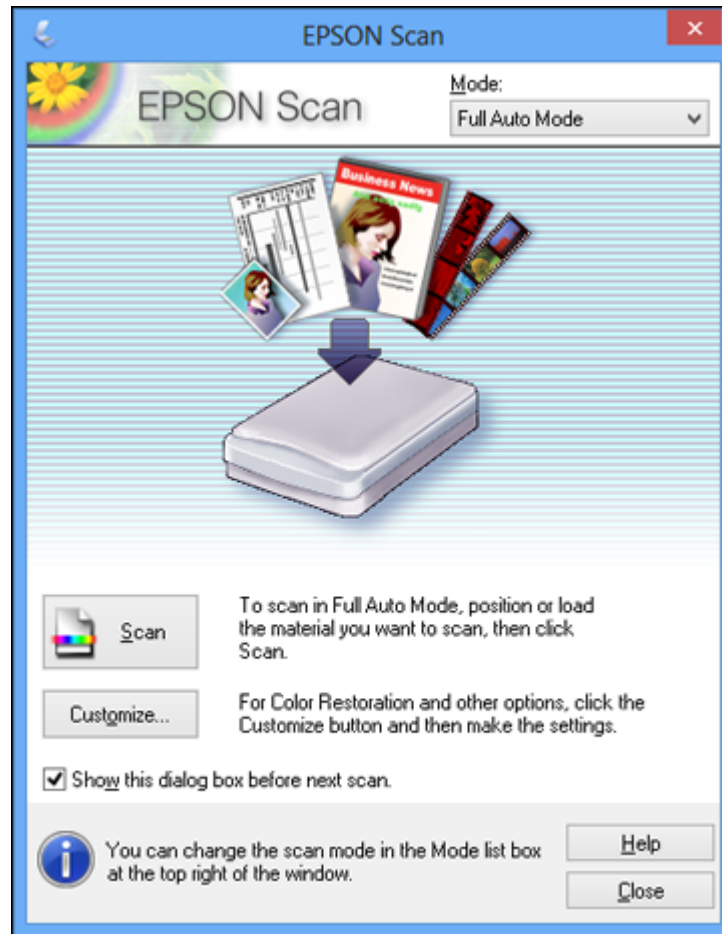

2. To select image adjustment options or change your scanned file settings, click **Customize**, select the settings you want, and click **OK**.

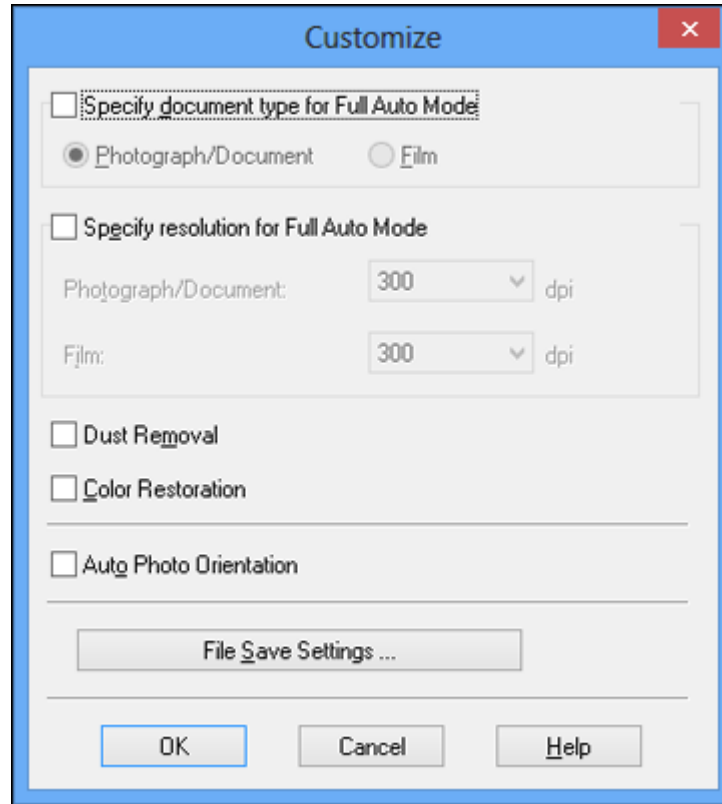

- To choose any of the available image adjustment options, select the checkbox for the option.
- To change the scanned file settings, click **File Save Settings**.

3. Click **Scan**.

Epson Scan scans your original, and saves the file in the selected folder or opens it in your scanning program. If the file was saved directly to your computer, you see the file in the Windows Explorer or OS X Finder, where you can view and print the image, if desired.

[Available Image Adjustments - Full Auto Mode](#)

Parent topic: [Selecting Epson Scan Settings](#)

Available Image Adjustments - Full Auto Mode

You can select these image adjustment options in Epson Scan Full Auto Mode.

Dust Removal

Removes dust marks from your originals automatically.

Color Restoration

Restores the colors in faded photos automatically.

Auto Photo Orientation

Checks the preview image for faces, the sky, and other features, and then correctly rotates the photo when it is scanned, if necessary. (If your photo is not oriented correctly using this option, deselect this option and scan again.)

Parent topic: [Scanning in Full Auto Mode](#)

Scanning in Home Mode

When you scan in Home Mode, Epson Scan automatically saves your scanned file in JPEG format in your operating system's Pictures or My Pictures folder, or opens it in your scanning program. You can select settings, preview, and change the scanned file settings as necessary.

1. Start Epson Scan and select **Home Mode** as the Mode setting.

You see this window:

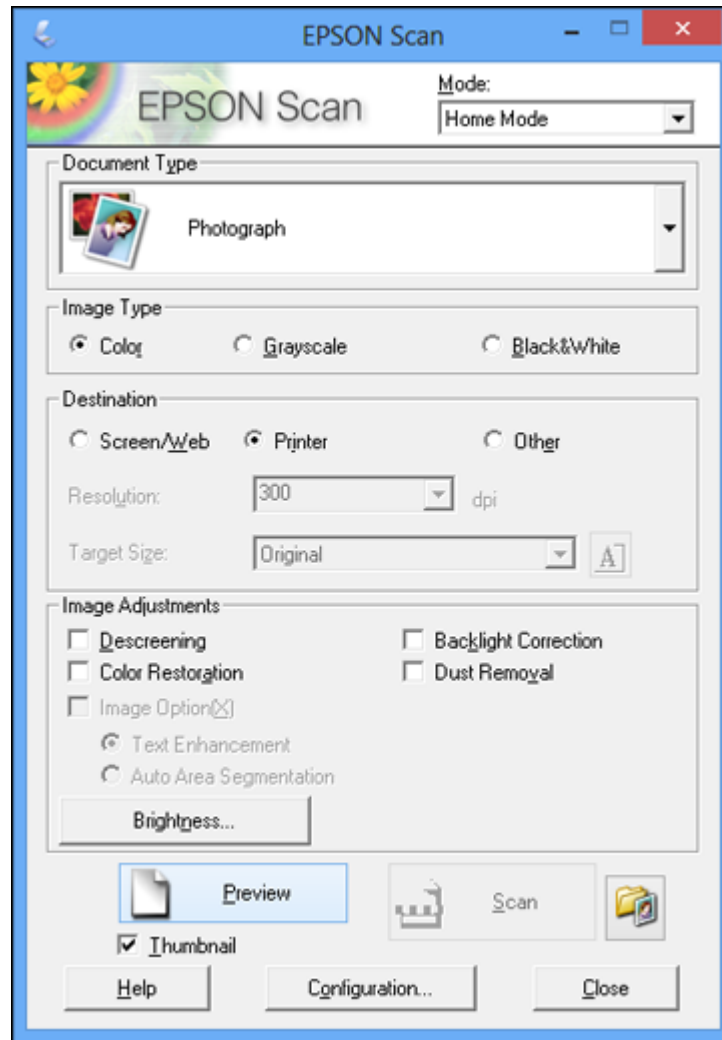

2. Select the **Document Type** setting that matches your original, such as **Photograph** or **Text/Line Art**.
3. Select the **Image Type** setting that matches your original.

4. Select the way you plan to use your scanned image as the **Destination** setting. (The Resolution setting is selected automatically based on the Destination setting you choose.)
 - **Screen/Web**: Select this option for images you will email, view on a computer screen, or post on the web.
 - **Printer**: Select this option for images you will print or documents you will convert to editable text using OCR (Optical Character Recognition) software.
 - **Other**: Select this option if you want to select a custom resolution for your image.
5. If you selected **Other** in the last step, select the **Resolution** setting you want to use for your scan.
6. Click the **Preview** button.

Epson Scan previews your original and displays the result in a separate Preview window.
7. If desired, select the area in your preview image that you want to scan (scan area).
8. Select any of the image adjustment settings you want to use. Before making adjustments, click the image or scan area in the Preview window.
9. If you want to reduce or enlarge your image as you scan, select the **Target Size** setting you want to use.
10. Click **Scan**.

You see the File Save Settings window.
11. Change any of the necessary file save settings and click **OK**.

Epson Scan scans your original, and saves the file in the selected folder or opens it in your scanning program. If the file was saved directly to your computer, you see the file in the Windows Explorer or OS X Finder, where you can view and print the image, if desired.

[Selecting a Scan Area - Home Mode](#)

[Available Image Adjustments - Home Mode](#)

[Selecting a Scan Size - Home Mode](#)

Parent topic: [Selecting Epson Scan Settings](#)

Related concepts

[Image Preview Guidelines](#)

[Scan Resolution Guidelines](#)

Related tasks

[Selecting Scan File Settings](#)

Selecting a Scan Area - Home Mode

You can select a specific area in your preview image to include in your scanned image. You can select the entire image area or a portion of it. You can even select multiple scan areas to create multiple scanned images of different areas (Normal Preview mode only).

You can also use the scan area to select specific Image Adjustments settings for a scanned image. Just be sure to click inside the scan area before selecting the settings.

1. Do one of the following to select your scan area in the Preview image:

- **Thumbnail preview:** Your scan area is selected automatically, but you can change it. Place your cursor in one corner of the desired scan area, then click and drag the cursor to the opposite corner to create a marquee (dotted line) on the preview image.

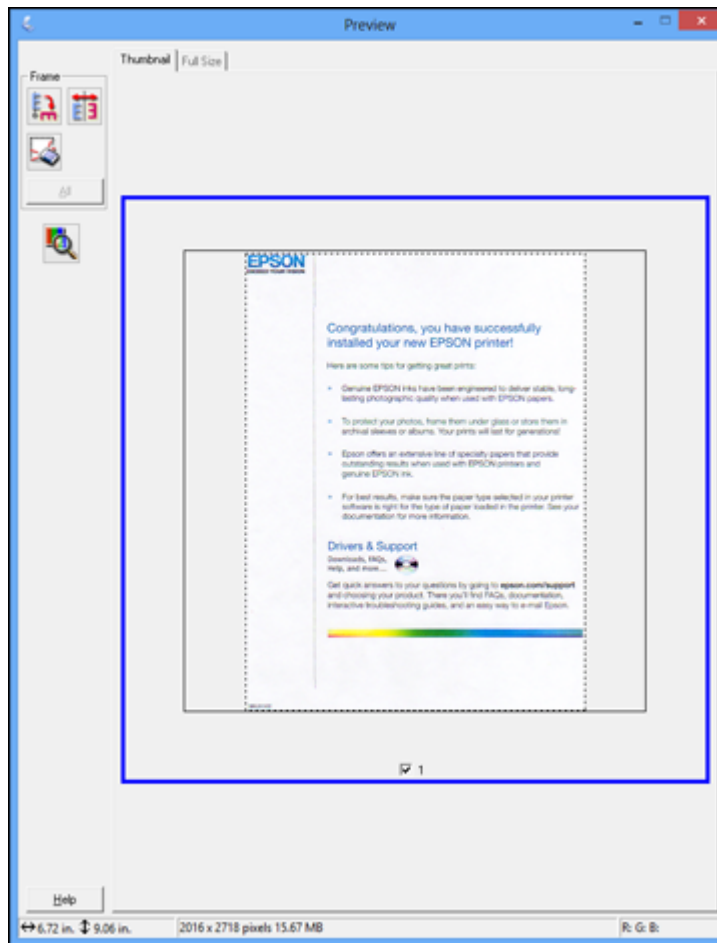

- **Normal preview:** Click the  Auto Locate icon to create a marquee (dotted line) on the preview image.

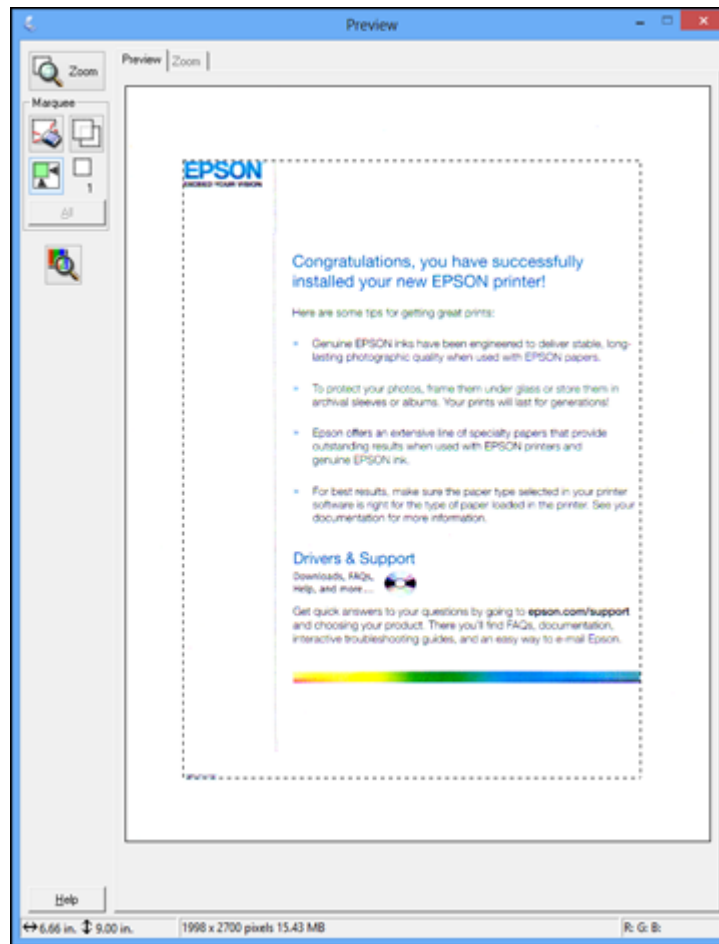

2. Do the following, as necessary, to work with the selected scan area:
 - If the marquee is correct, continue with the next step.
 - To move the marquee, click inside the scan area and drag the marquee where you want it.

- To resize the scan area, place your cursor over the edge or corner of the marquee, then click and drag the edges where you want them. (Hold down the **Shift** key as you resize the marquee to retain the same width/height proportions.)
- **Normal preview:** To create additional marquees (up to 50), click the  Copy Marquee icon to copy the existing marquee and paste it on the preview image.

Note: If you draw multiple marquees, make sure you select the **All** button in the Preview window before you scan. Otherwise, only the area inside the currently selected marquee will be scanned.

- To delete a marquee, click the marquee, then click the  Delete Marquee icon.

3. Click inside the scan area and make any necessary settings in the Epson Scan window.

Parent topic: [Scanning in Home Mode](#)

Available Image Adjustments - Home Mode

You can select these Image Adjustments options in Epson Scan Home Mode.

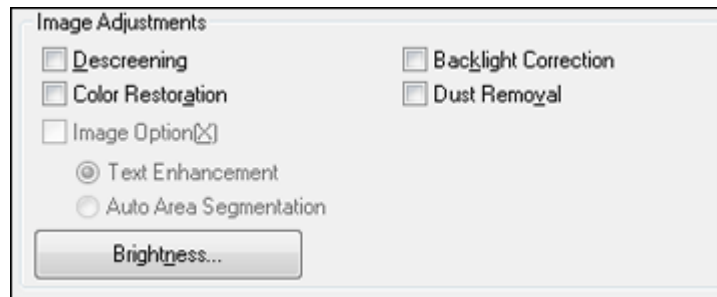

Note: Select the **Image Option** checkbox if you need to set any of the grayed-out image adjustments. Not all adjustment settings may be available, depending on the Document Type and Image Type setting. Click the **Brightness** button to access additional settings.

Descreening

Removes the ripple pattern that might appear in subtly shaded image areas, such as skin tones. This option improves results when scanning magazines or newspapers. (The results of descreening do not appear in the preview image, only in your scanned image.)

Color Restoration

Restores the colors in faded photos automatically.

Backlight Correction

Removes shadows from photos that have too much background light.

Dust Removal

Removes dust marks from your originals automatically.

Text Enhancement

Sharpens the appearance of letters in text documents.

Auto Area Segmentation

Makes grayscale images clearer and text recognition more accurate by separating the text from the graphics.

Brightness

Adjusts the overall lightness and darkness of the scanned image.

Contrast

Adjusts the difference between the light and dark areas of the overall scanned image.

Threshold

Adjusts the level at which black areas in text and line art are delineated, improving text recognition in OCR (Optical Character Recognition) programs.

Parent topic: [Scanning in Home Mode](#)

Selecting a Scan Size - Home Mode

You can reduce or enlarge the size of your image as you scan. You can also select a specific scan size, such as a common photo size like 4 × 6 inches (102 × 152 mm). This places a scan area of that size on the preview image so you can use it to help crop the image in the correct proportions.

1. Click the **Preview** button to preview your image.
2. In the Epson Scan window, select the size you want your scanned image to be from the **Target Size** list.

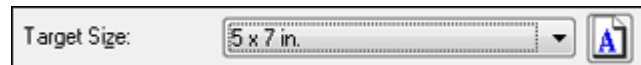

Note: If you need to rotate the orientation of the target size for your image, click the  Orientation icon.

A marquee (dotted line) appears on your preview image proportioned for the size you selected.

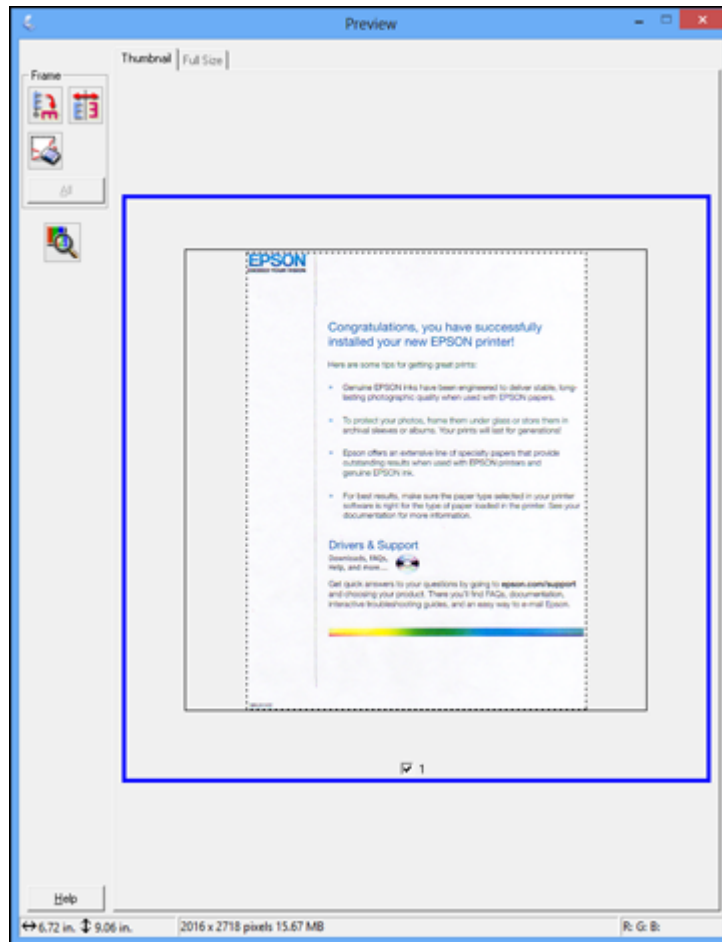

3. Do the following, as necessary, to work with the selected scan area:
 - To move the marquee, click inside the scan area and drag the marquee where you want it.

- To resize the scan area, place your cursor over the edge or corner of the marquee, then click and drag the edge where you want it.

Note: Manually adjusting the marquee will not change the target size of the scanned file. The marquee only indicates the area of the image that will be scanned.

4. To create a scanned image size that is not available in the Target Size list, click the **Customize** option.

You see this window:

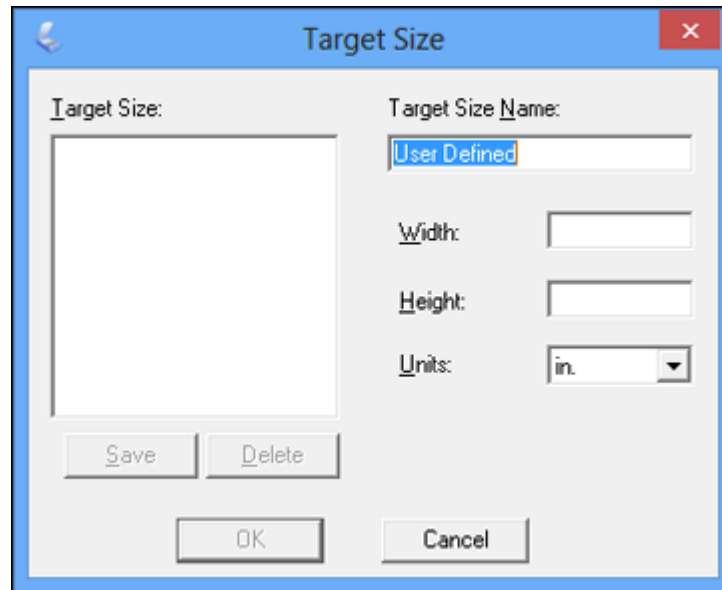

5. Name the custom size, enter the size, click **Save**, and click **OK**. Then adjust the marquee on the preview image.

The marquee is automatically proportioned for your custom scan size.

Parent topic: [Scanning in Home Mode](#)

Scanning in Office Mode

When you scan in Office Mode, Epson Scan automatically saves your scanned file in JPEG format in your operating system's Pictures or My Pictures folder, or opens it in your scanning program. You can select settings, preview, and change the scanned file settings as necessary.

1. Start Epson Scan and select **Office Mode** as the Mode setting.

You see this window:

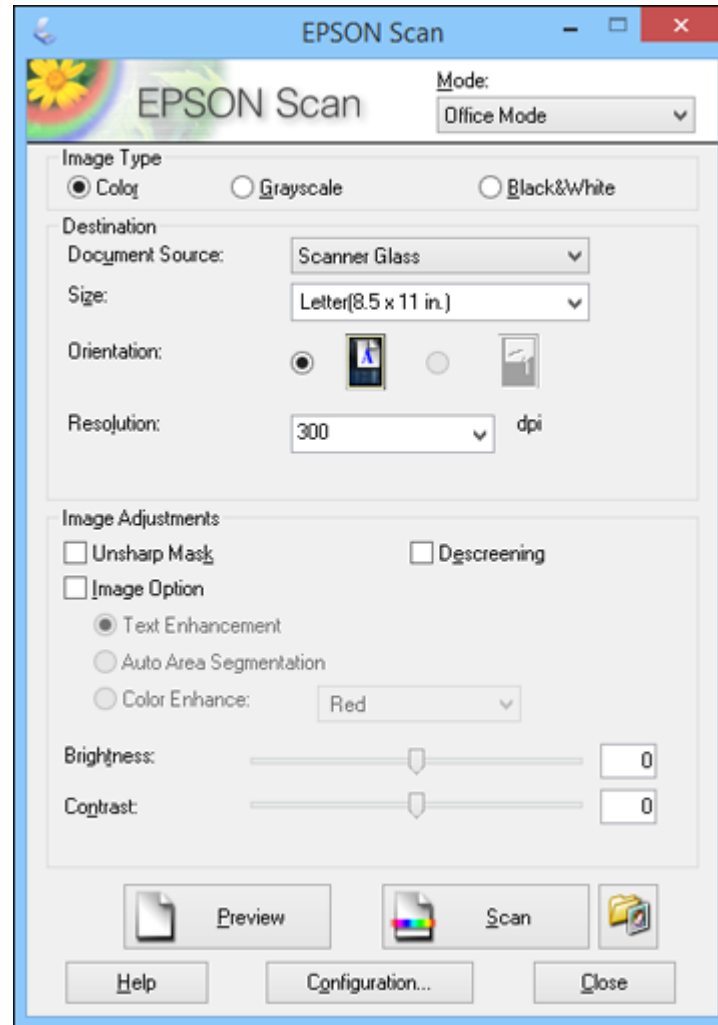

2. Select the **Image Type** setting that matches your original.
3. Select the **Document Source** setting indicating where you placed your original.
4. Select the **Size** and **Orientation** settings that match your original.
5. Select the **Resolution** setting you want to use for your scan.
6. Click the **Preview** button.
Epson Scan previews your original and displays the result in a separate Preview window.
7. If desired, select the area in your preview image that you want to scan (scan area).
8. Select any of the image adjustment settings you want to use. Before making adjustments, click the image or scan area in the Preview window.
9. Click **Scan**.
You see the File Save Settings window.
10. Change any of the necessary file save settings and click **OK**.

Epson Scan scans your original, and saves the file in the selected folder or opens it in your scanning program. If the file was saved directly to your computer, you see the file in the Windows Explorer or OS X Finder, where you can view and print the image, if desired.

[Selecting a Scan Area - Office Mode](#)

[Available Image Adjustments - Office Mode](#)

Parent topic: [Selecting Epson Scan Settings](#)

Related concepts

[Image Preview Guidelines](#)

[Scan Resolution Guidelines](#)

Related tasks

[Selecting Scan File Settings](#)

Selecting a Scan Area - Office Mode

You can select a specific area in your preview image to include in your scanned image. You can select the entire image area or a portion of it. You can even select multiple scan areas to create multiple scanned images of different areas.

You can also use the scan area to select specific Image Adjustments settings for a scanned image. Just be sure to click inside the scan area before selecting the settings.

1. In the Preview window, click the  Auto Locate icon to create a marquee (dotted line) on the preview image.

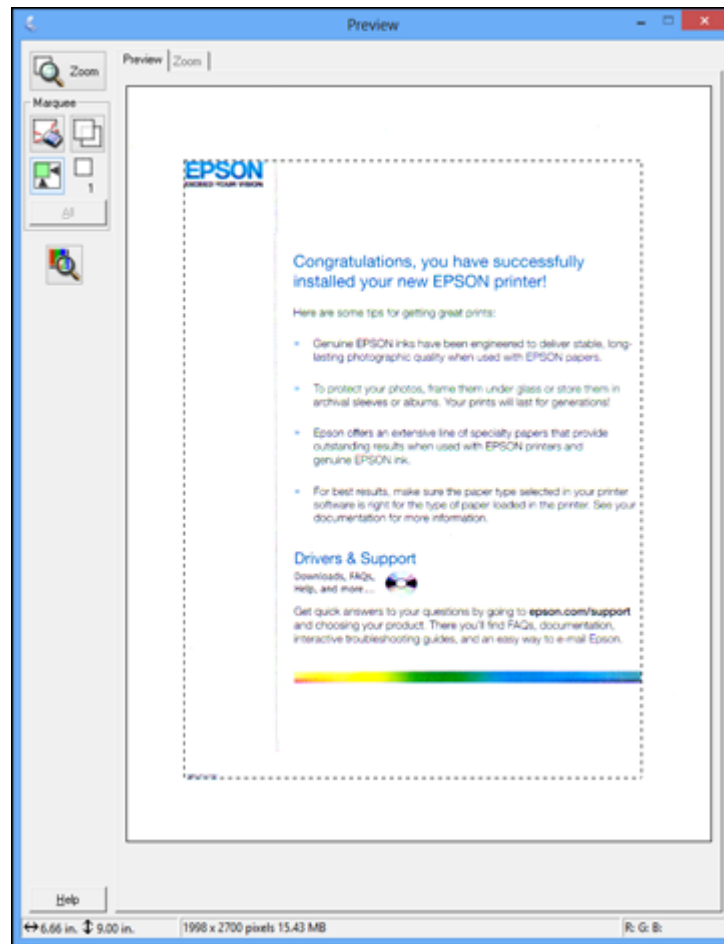

2. Do the following, as necessary, to work with the selected scan area:
 - If the marquee is correct, continue with the next step.
 - To move the marquee, click inside the scan area and drag the marquee where you want it.

- To resize the scan area, place your cursor over the edge or corner of the marquee, then click and drag the edges where you want them. (Hold down the **Shift** key as you resize the marquee to retain the same width/height proportions.)
- To create additional marquees (up to 50, if available), click the  Copy Marquee icon to copy the existing marquee and paste it on the preview image.

Note: If you draw multiple marquees, make sure you select the **All** button in the Preview window before you scan. Otherwise, only the area inside the currently selected marquee will be scanned.

- To delete a marquee, click the marquee, then click the  Delete Marquee icon.

3. Click inside each scan area and make any necessary settings in the Epson Scan window.

Parent topic: [Scanning in Office Mode](#)

Available Image Adjustments - Office Mode

You can select these Image Adjustments options in Epson Scan Office Mode. Not all adjustment settings may be available, depending on other settings you have chosen.

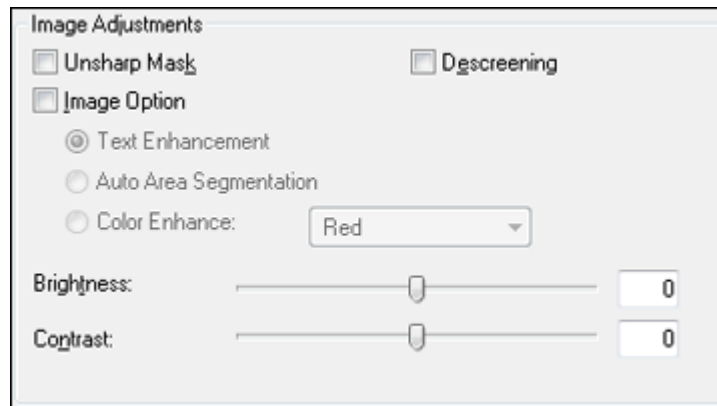

Note: Select the **Image Option** checkbox if you need to set any of the grayed-out image adjustments beneath the checkbox. Not all adjustment settings may be available, depending on the Image Type setting.

Unsharp Mask

Makes the edges of certain image areas clearer. Turn off this option to leave softer edges.

Descreening

Removes the ripple pattern that might appear in subtly shaded image areas, such as skin tones. This option improves results when scanning magazines or newspapers. (The results of descreening do not appear in the preview image, only in your scanned image.)

Text Enhancement

Sharpens the appearance of letters in text documents.

Auto Area Segmentation

Makes grayscale images clearer and text recognition more accurate by separating the text from the graphics.

Color Enhance

Enhances the red, green, or blue shades in the scanned image.

Brightness

Adjusts the overall lightness and darkness of the scanned image.

Contrast

Adjusts the difference between the light and dark areas of the overall scanned image.

Threshold

Adjusts the level at which black areas in text and line art are delineated, improving text recognition in OCR (Optical Character Recognition) programs.

Parent topic: [Scanning in Office Mode](#)

Scanning in Professional Mode

When you scan in Professional Mode, Epson Scan automatically saves your scanned file in JPEG format in your operating system's Pictures or My Pictures folder, or opens it in your scanning program. You can select settings, preview, and change the scanned file settings as necessary.

1. Start Epson Scan and select **Professional Mode** as the Mode setting.

You see this window:

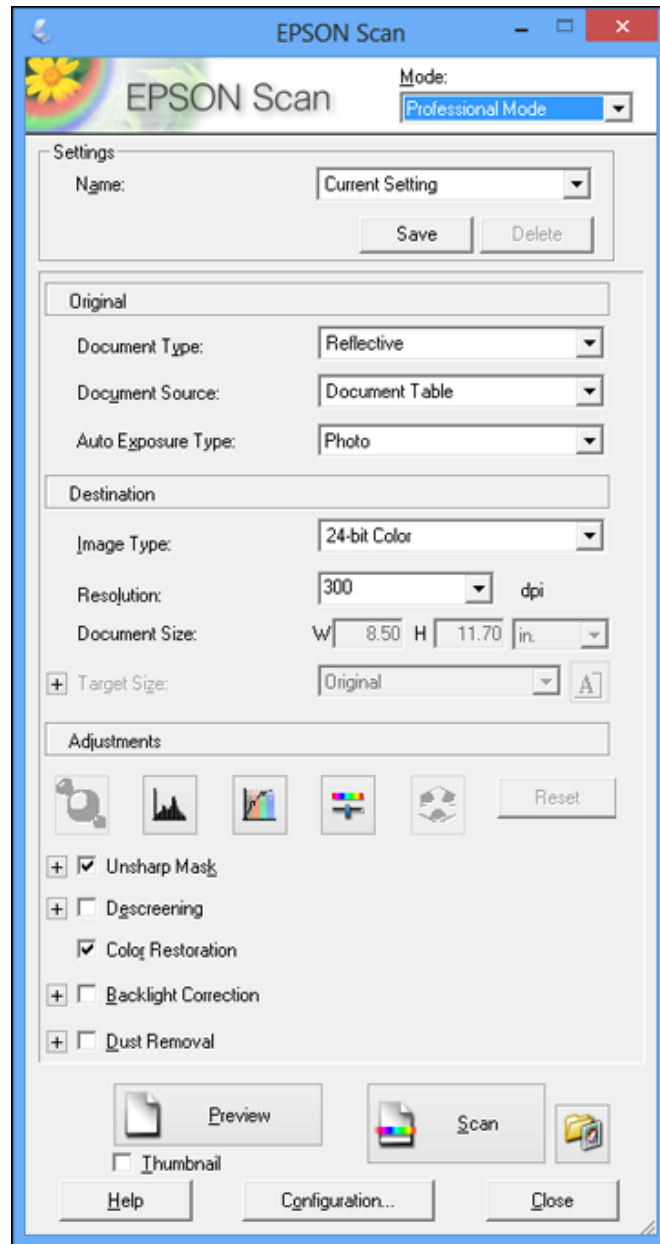

2. Select the **Document Type** setting that matches your original, such as **Reflective** for documents or photos.
3. Select the **Document Source** setting indicating where you placed your original.
4. Select the specific type of original you are scanning as the **Auto Exposure Type** setting: **Document** or **Photo**.
5. Select the details of your original and how you want it scanned as the **Image Type** setting.
6. Select the **Resolution** setting you want to use for your scan.
7. Click the **Preview** button.

Epson Scan previews your original and displays the result in a separate Preview window.

8. If desired, select the area in your preview image that you want to scan (scan area).
9. Select any of the image adjustment settings you want to use. Before making adjustments, click the image or scan area in the Preview window.
10. If you want to reduce or enlarge your image as you scan, select the **Target Size** setting you want to use.
11. Click **Scan**.

You see the File Save Settings window.

12. Change any of the necessary file save settings and click **OK**.

Epson Scan scans your original, and saves the file in the selected folder or opens it in your scanning program. If the file was saved directly to your computer, you see the file in the Windows Explorer or OS X Finder, where you can view and print the image, if desired.

[Available Image Types - Professional Mode](#)

[Selecting a Scan Area - Professional Mode](#)

[Available Image Adjustments - Professional Mode](#)

[Selecting a Scan Size - Professional Mode](#)

Parent topic: [Selecting Epson Scan Settings](#)

Related concepts

[Image Preview Guidelines](#)

[Scan Resolution Guidelines](#)

Related tasks

[Selecting Scan File Settings](#)

Available Image Types - Professional Mode

You can select these Image Type options in Epson Scan Professional Mode.

24-bit Color

Select this setting for color photos.

Color Smoothing

Select this setting for color graphic images, such as charts or graphs.

8-bit Grayscale

Select this setting for black-and-white photos.

Black & White

Select this setting for black text documents or line art.

Parent topic: [Scanning in Professional Mode](#)

Selecting a Scan Area - Professional Mode

You can select a specific area in your preview image to include in your scanned image. You can select the entire image area or a portion of it. You can even select multiple scan areas to create multiple scanned images of different areas (Normal Preview mode only).

You can also use the scan area to select specific image Adjustments settings for a scanned image. Just be sure to click inside the scan area before selecting the settings.

Note: In Professional Mode, the default Preview mode is Normal Preview mode. To use Thumbnail Preview mode instead, select the **Thumbnail** checkbox beneath the Preview button (if available), then click the **Preview** button to preview your image again.

1. Do one of the following to select your scan area in the Preview image:

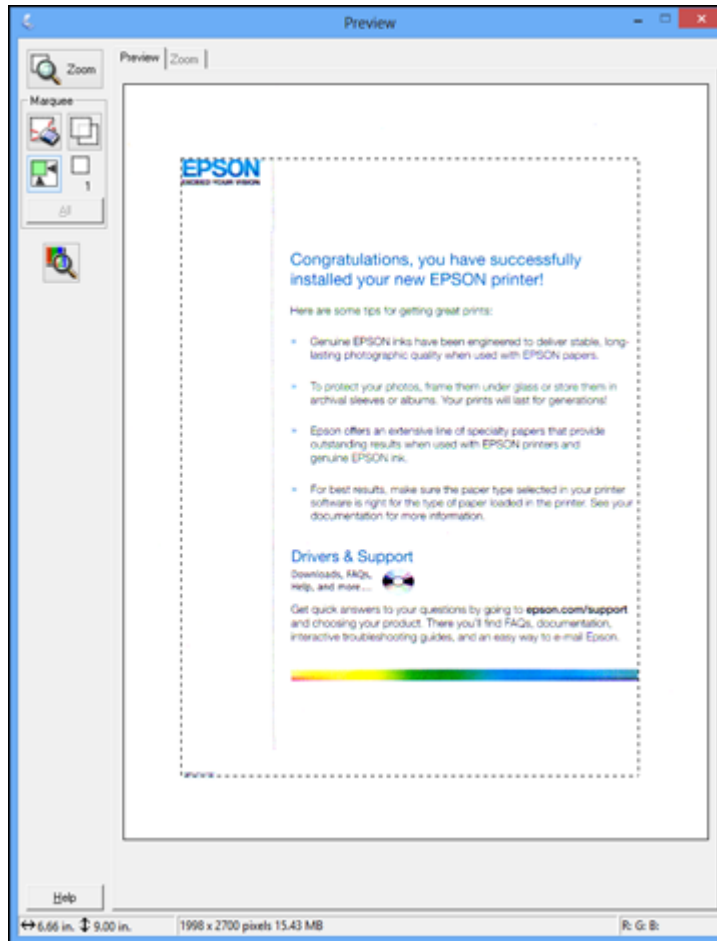

- **Normal preview:** Click the  Auto Locate icon to create a marquee (dotted line) on the preview image.

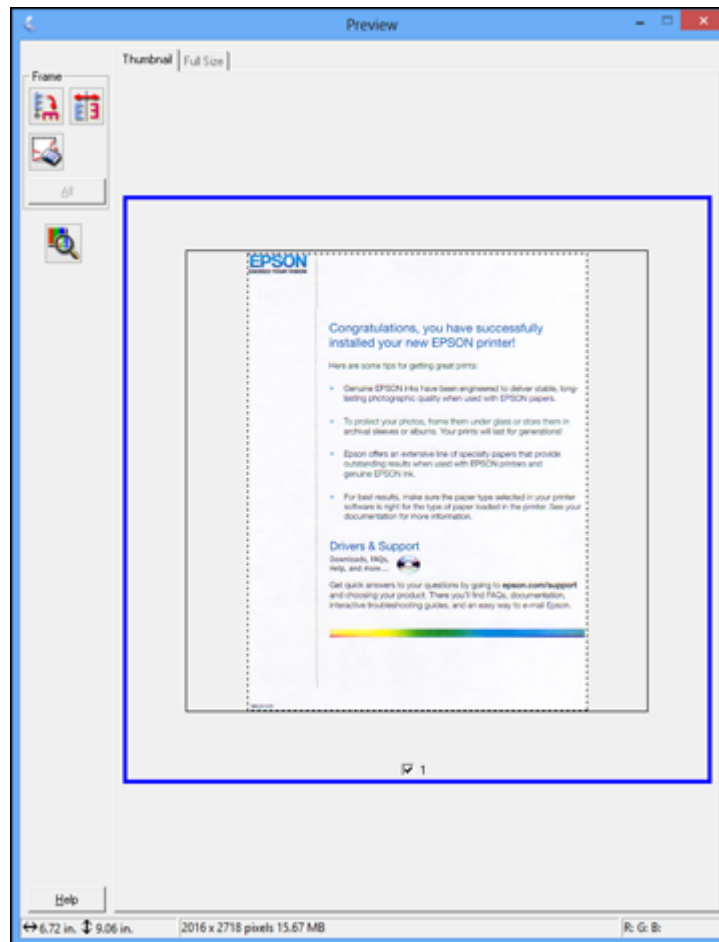

- **Thumbnail preview:** Your scan area is selected automatically, but you can change it. Place your cursor in one corner of the desired scan area, then click and drag the cursor to the opposite corner to create a marquee (dotted line) on the preview image.



2. Do the following, as necessary, to work with the selected scan area:
 - If the marquee is correct, continue with the next step.
 - To move the marquee, click inside the scan area and drag the marquee where you want it.

- To resize the scan area, place your cursor over the edge or corner of the marquee, then click and drag the edges where you want them. (Hold down the **Shift** key as you resize the marquee to retain the same width/height proportions.)
- **Normal preview:** To create additional marquees (up to 50, if available), click the  Copy Marquee icon to copy the existing marquee and paste it on the preview image.
- To delete a marquee, click the marquee, then click the  Delete Marquee icon.

Note: If you draw multiple marquees, make sure you select the **All** button in the Preview window before you scan. Otherwise, only the area inside the currently selected marquee will be scanned.

3. Click inside the scan area and make any necessary settings in the Epson Scan window.

Parent topic: [Scanning in Professional Mode](#)

Available Image Adjustments - Professional Mode

You can select these Adjustments options in Epson Scan Professional Mode. Not all adjustment settings may be available, depending on other settings you have chosen.

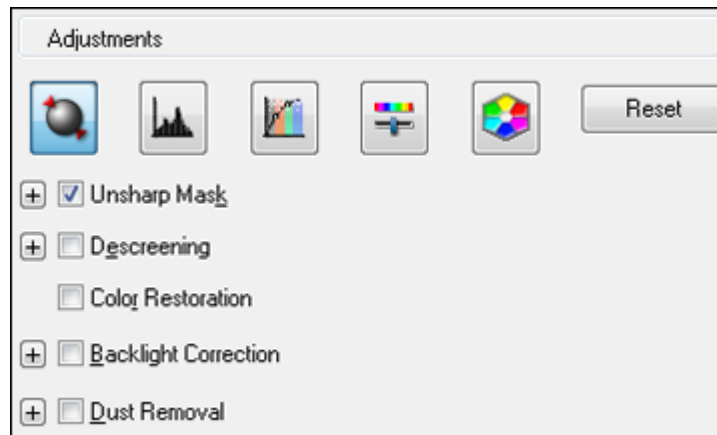

Click the  image adjustment icon to access additional settings.

Click the **+** (Windows) or **▶** (OS X) icon next to a setting to change the level of adjustment.

Unsharp Mask

Makes the edges of certain image areas clearer. Turn off this option to leave softer edges.

Descreening

Removes the ripple pattern that might appear in subtly shaded image areas, such as skin tones. This option improves results when scanning magazines or newspapers. (The results of descreening do not appear in the preview image, only in your scanned image.)

Color Restoration

Restores the colors in faded photos automatically.

Backlight Correction

Removes shadows from photos that have too much background light.

Dust Removal

Removes dust marks from your originals automatically.

Auto Exposure

Automatically adjusts the image exposure settings when you click the  Auto Exposure icon. To automatically adjust image exposure settings continuously, click the **Configuration** button, click the **Color** tab, and select **Continuous auto exposure**. You can adjust the level of auto exposure using a slider.

Histogram Adjustment

Provides a graphical interface for adjusting highlight, shadow, and gamma levels individually. (For advanced users only.) Click the  histogram icon to access the settings.

Tone Correction

Provides a graphical interface for adjusting tone levels individually. (For advanced users only.) Click the  tone correction icon to access the settings.

Brightness

Adjusts the overall lightness and darkness of the scanned image.

Contrast

Adjusts the difference between the light and dark areas of the overall scanned image.

Saturation

Adjusts the density of colors in the overall image.

Color Balance

Adjusts the balance of colors in the overall image.

Color Palette

Provides a graphical interface for adjusting mid-tone levels, such as skin tones, without affecting the highlight and shadow areas of the image. (For advanced users only.) Click the  Color Palette icon to access the settings.

Threshold

Adjusts the level at which black areas in text and line art are delineated, improving text recognition in OCR (Optical Character Recognition) programs.

Parent topic: [Scanning in Professional Mode](#)

Selecting a Scan Size - Professional Mode

You can reduce or enlarge the size of your image as you scan. You can also select a specific scan size, such as a common photo size like 4 × 6 inches (102 × 152 mm). This places a scan area of that size on the preview image so you can use it to help crop the image in the correct proportions.

1. Click the **Preview** button to preview your image.
2. In the Epson Scan window, select the size you want your scanned image to be from the **Target Size** list.

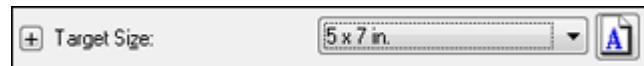

Note: If you need to rotate the orientation of the target size for your image, click the  orientation icon.

A marquee (dotted line) appears on your preview image proportioned for the size you selected.

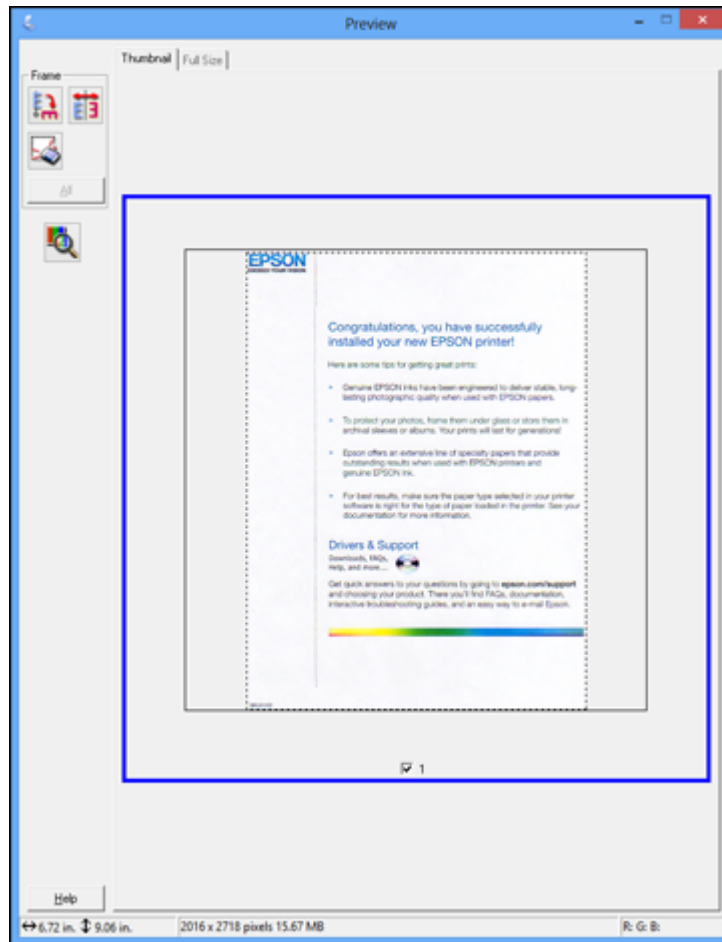

3. Do the following, as necessary, to work with the selected scan area:
 - To move the marquee, click inside the scan area and drag the marquee where you want it.

- To resize the scan area, place your cursor over the edge or corner of the marquee, then click and drag the edge where you want it.

Note: Manually adjusting the marquee will not change the target size of the scanned file. The marquee only indicates the area of the image that will be scanned.

4. To create a scanned image size that is not available in the Target Size list, click the **Customize** option.

You see this window:

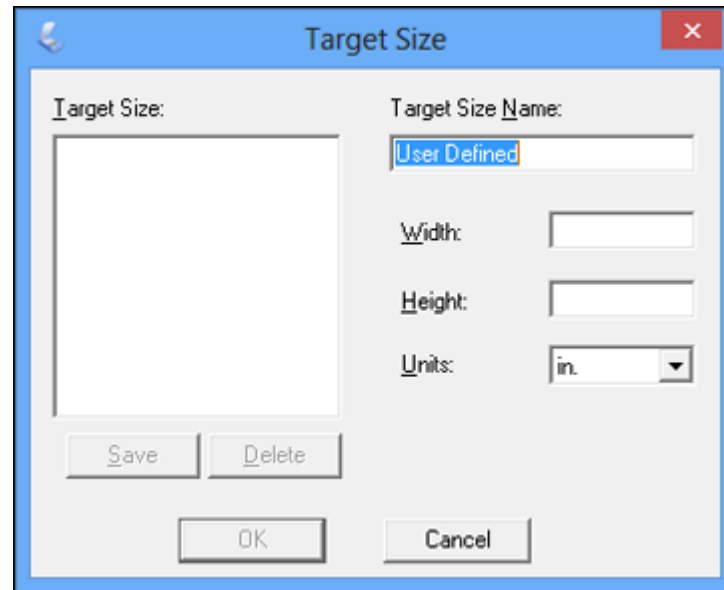

5. Name the custom size, enter the size, click **Save**, and click **OK**. Then adjust the marquee on the preview image.

The marquee is automatically proportioned for your custom scan size.

- To use additional sizing tools, click the + (Windows) or ► (OS X) icon next to the Target Size setting and select options as desired.

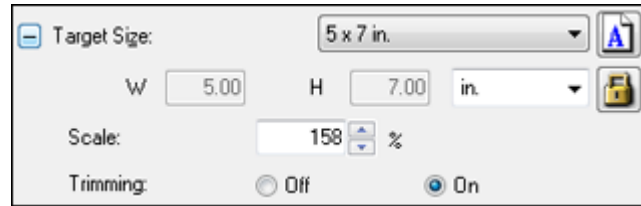

- **Scale:** Reduces or enlarges your image by the percentage you enter.
- **Trimming:** Turns automatic image cropping on or off.
-  **Unlock icon:** Unlocks the width/height proportions of the scanned image size so you can adjust it without constraint.

Parent topic: [Scanning in Professional Mode](#)

Image Preview Guidelines

You can preview your scanned image so you can adjust the scan settings using the preview as a guide. There are two types of preview available, depending on the scan mode and selected settings:

Thumbnail preview

A thumbnail preview displays your previewed images as thumbnails with the scanned image area and exposure automatically selected. If the **Thumbnail** checkbox is selected, clicking the **Preview** button opens a thumbnail preview.

Normal preview

A normal preview displays your previewed images in their entirety so you can select the scanned image area and other settings manually. If the **Thumbnail** checkbox is deselected, clicking the **Preview** button opens a normal preview.

Parent topic: [Selecting Epson Scan Settings](#)

Scan Resolution Guidelines

If you plan to enlarge a scanned image so you can print it at a larger size, you may need to increase the resolution from the default resolution set by Epson Scan. Follow these guidelines to determine the resolution setting you need:

- You will enlarge the image as you scan it.

If you will enlarge the image using Epson Scan's Target Size setting, you do not need to increase the Resolution setting.

- You will scan the image at its original size but enlarge it later in an image-editing program.

Increase Epson Scan's Resolution setting in your scan. Increase the resolution by the same amount you will increase the image size to retain a high image quality. For example, if the resolution is 300 dpi (dots per inch) and you will double the image size later, change the Resolution setting to 600 dpi.

- You will scan the image at 100% or smaller size.

Select Epson Scan's Resolution setting based on how you will use the scanned image:

- Email/view on a computer screen/post on the web: 96 to 150 dpi
- Print/convert to editable text (OCR): 300 dpi
- Fax: 200 dpi

Parent topic: [Selecting Epson Scan Settings](#)

Selecting Scan File Settings

You can select the location, name, and format of your scan file on the File Save Settings window. You can also select various optional settings that control how Epson Scan behaves when you scan and save files.

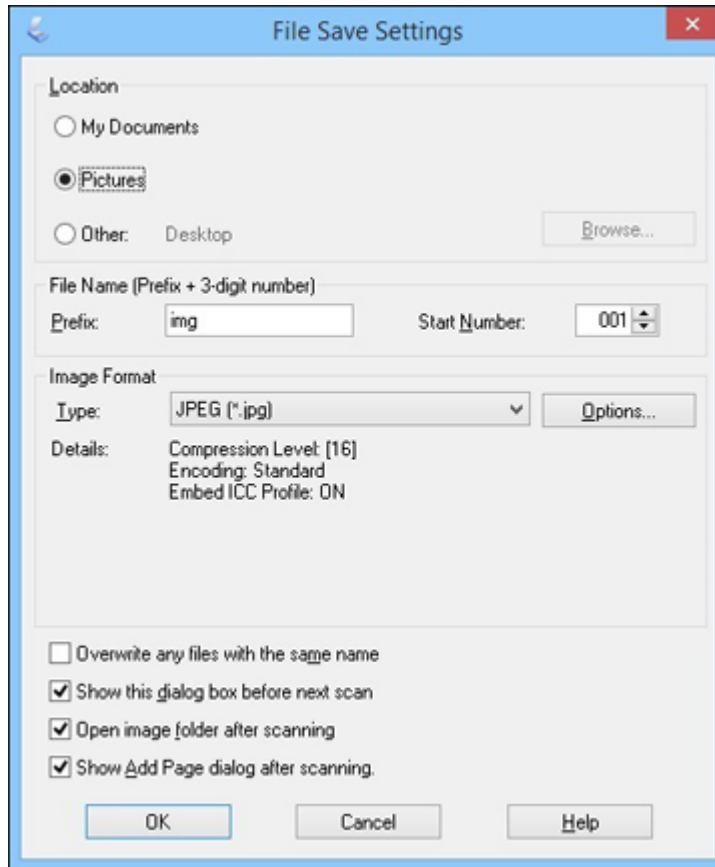

The File Save Settings window may appear after you click **Scan** on the Epson Scan window. You may also be able to access the window by clicking the  icon on the Epson Scan window.

1. Do one of the following to select the folder in which you want to save your scanned image:
 - Click the button for one of the displayed folders.

- Click the **Other** button, click the **Browse** or **Choose** button, and select a folder.
- 2. Type in a file name in the **Prefix** field. This name is used along with numbers to automatically name your scanned files.
- 3. Select a different number as the **Start Number** setting, if you like.
- 4. Select the file format you want to use in the Image Format **Type** menu.
- 5. If your file format provides optional settings, click the **Options** button to select them.
- 6. Choose any of the optional settings you want to use by selecting their checkboxes.
- 7. Click **OK**.

[Available Scanned File Types and Optional Settings](#)

Parent topic: [Selecting Epson Scan Settings](#)

Available Scanned File Types and Optional Settings

You can select from a variety of scanned file types and optional settings on the File Save Settings window in Epson Scan.

File Formats

Bitmap (*.bmp)

A standard image file format for most Windows programs.

JPEG (*.jpg)

An image format that lets you highly compress image data. However, the higher the compression, the lower the image quality. (The TIFF format is recommended when you need to modify or retouch your scanned image.)

Multi-TIFF (*.tif)

A TIFF file format when multiple pages are saved to the same file, allowing you to edit the images using a compatible program.

PDF (*.pdf)

A document format that is readable by Windows and OS X systems using Adobe Reader, Acrobat, or other programs. You can save multi-page documents in one PDF file.

PICT (*.pct)

A standard image file format for most OS X programs.

PRINT Image Matching II (*.jpg or *.tif)

File formats that include Epson PRINT Image Matching II data for enhanced quality and a wider color range (does not affect the way the image displays on the screen).

TIFF (*.tif)

A file format created for exchanging data between many programs, such as graphic and DTP software.

Optional Settings**Overwrite any files with the same name**

Select to overwrite previous files with the same names.

Show this dialog box before next scan

Select to have the File Save Settings window appear automatically before you scan (in certain Epson Scan modes).

Open image folder after scanning

Select to have Windows Explorer or OS X Finder automatically open to the folder where your scanned image is saved after scanning.

Show Add Page dialog after scanning

If you are scanning a multi-page document using the PDF or Multi-TIFF format, select to display a prompt for scanning additional pages after the first page is scanned.

Parent topic: [Selecting Scan File Settings](#)

Scanning with OS X Using Image Capture

With OS X, you can scan with your product using an image-editing application such as Image Capture.

Note: With OS X, in addition to scanning with Image Capture, you can download and install Epson Scan scanning software. Epson Scan provides additional image adjustment and photo correction features for enhancing scanned images, and provides an interface for TWAIN-compliant OCR scanning software. To download Epson Scan, visit Epson's driver download site ([U.S. downloads](#) or [Canadian downloads](#)).

1. Open an image editing application, such as Image Capture.
2. Select your Epson product from the **DEVICES** or **SHARED** list in the Finder, if necessary. (You may need to hover over the **DEVICES** or **SHARED** list, click **Show**, and select your product.)
3. If you see the **Show Details** button, click it.

If you are scanning an item on the scanner glass, your product begins a preview scan.

4. Select the **Scan Mode** setting indicating where you placed your original (if available). Select any other available scan settings as necessary.

The image shows a scan software settings window with the following configuration:

- Scan Mode: Flatbed
- Kind: Color
- Resolution: 50 dpi
- Use Custom Size
- Size: 4.21 x 2.49 inches
- Rotation Angle: 0.25°
- Auto Selection: Detect Separate Items
- Scan To: Pictures
- Name: Scan
- Format: JPEG
- Image Correction: None
- Unsharp Mask: None
- Descreening: None
- Backlight Correction: None
- Dust Removal: None
- Color Restoration

Buttons at the bottom: Hide Details, Overview, Scan

5. Select the folder in which you want to save your scanned file in the **Scan To** pop-up menu.
6. Click **Scan**.

Your scanned file is saved in the folder you selected.

[Available Scan Settings - OS X Image Capture](#)

Parent topic: [Scanning](#)

Available Scan Settings - OS X Image Capture

You can select these scan settings in your imaging editing application for OS X, if available.

Image Correction

Provides a graphical interface for adjusting brightness, tint, temperature, and saturation.

Unsharp Mask

Makes the edges of certain image areas clearer. Turn off this option to leave softer edges.

Descreening

Removes the ripple pattern that might appear in subtly shaded image areas, such as skin tones. This option improves results when scanning magazines or newspapers. (The results of descreening do not appear in the preview image, only in your scanned image.)

Backlight Correction

Removes shadows from photos that have too much background light.

Dust Removal

Removes dust marks from your originals automatically.

Color Restoration

Restores the colors in faded photos automatically.

Parent topic: [Scanning with OS X Using Image Capture](#)

Scanning Special Projects

Your product's scanning software offers various options to help you quickly complete special scan projects.

[Scanning to a PDF File](#)

[Restoring Photo Colors as You Scan](#)

Parent topic: [Scanning](#)

Scanning to a PDF File

Using Epson Scan, you can scan a multi-page document and save it in one PDF (Portable Document Format) file on your computer.

1. Place your original on your product for scanning.
2. Start Epson Scan.
3. Select the scan mode you want to use.
4. Select the scan settings for your scan.
5. Preview your image.
6. When you finish selecting all your settings, click **Scan**.

You see the File Save Settings window.

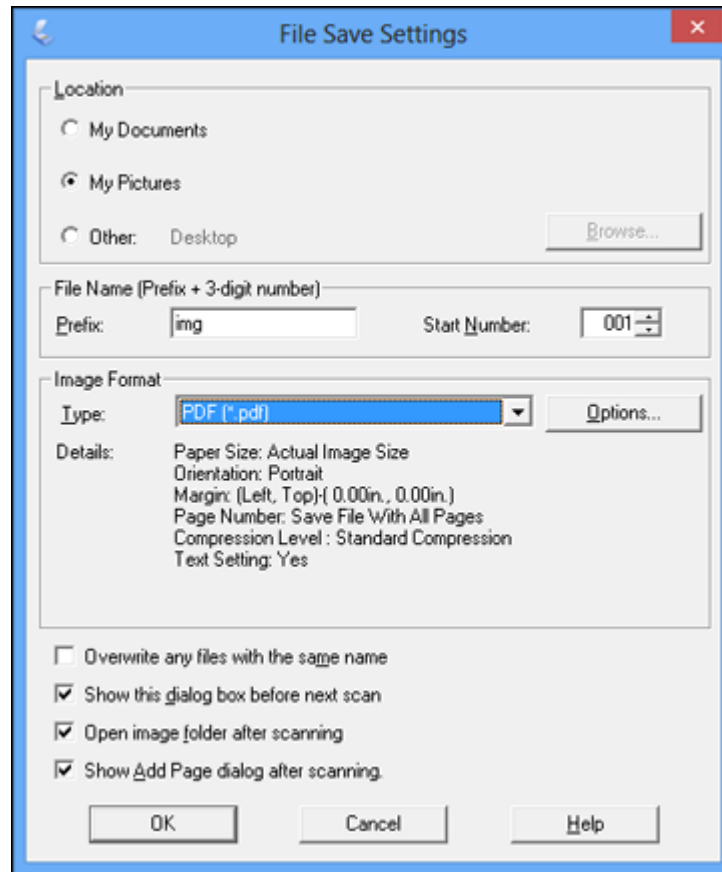

7. Select **PDF** as the Type setting.
8. Select any other settings you want to use on the File Save Settings window. Click the **Options** button to access additional settings.
9. Click **OK**.

Epson Scan scans your document and you see this window:

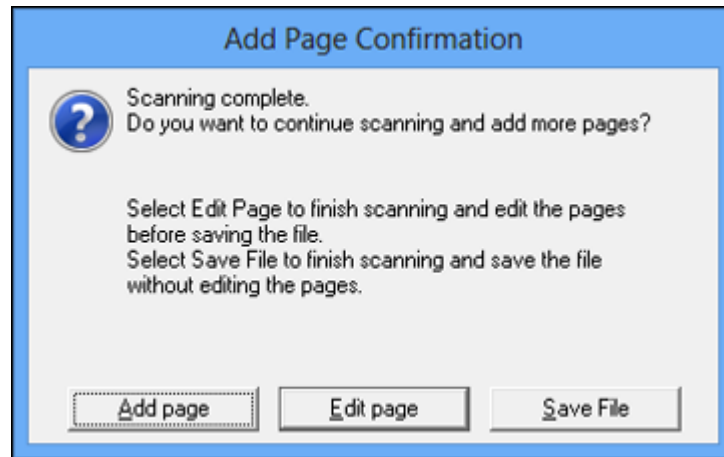

10. Choose one of the following options:

- If you are scanning only one page, click **Save File**.
- If you need to scan additional pages in a document, click **Add page**. Place additional pages on the product for scanning, click **Scan**, and repeat until you have scanned all the pages. When you are finished, click **Save File**.
- If you need to delete or reorder the scanned pages, click **Edit page**. Delete or reorder the pages using the icons that appear on the bottom of the editing window. When you are finished, click **OK**.

Note: If you installed an OCR (Optical Character Recognition) program, you may see a screen indicating the program is converting your page to text. Wait until the program re-scans the page and close the program, if necessary.

11. Click **Close** to exit the Epson Scan window, if necessary.

Epson Scan scans your original, and saves the PDF file in the selected folder or opens it in your scanning program. If the file was saved directly to your computer, you see the file in the Windows Explorer or OS X Finder, where you can view and print the document, if desired.

Parent topic: [Scanning Special Projects](#)

Related tasks

[Placing Originals on the Scanner Glass](#)

[Selecting the Scan Mode](#)

[Selecting Scan File Settings](#)

Related topics

[Starting a Scan](#)

Restoring Photo Colors as You Scan

You can restore the colors in faded photos as you scan them using Epson Scan's Color Restoration setting. You can select this setting in any of the available scan modes.

Note: Color restoration is not available in Office Mode, if Epson Scan offers that mode.

1. Place your original on your product for scanning.
2. Start Epson Scan.
3. Select the scan mode you want to use.
4. Select the scan settings for your scan.
5. Preview your image.
6. Locate or access the image adjustment settings.
7. Select the **Color Restoration** checkbox.



8. When you finish selecting all your settings, click **Scan**.
9. Click **Close** to exit the Epson Scan window, if necessary.

Epson Scan scans your original, and saves the color-restored file in the selected folder or opens it in your scanning program. If the file was saved directly to your computer, you see the file in the Windows Explorer or OS X Finder, where you can view and print the image, if desired.

Parent topic: [Scanning Special Projects](#)

Related tasks

[Placing Originals on the Scanner Glass](#)

[Selecting the Scan Mode](#)

[Selecting Scan File Settings](#)

Related topics

[Starting a Scan](#)

Refilling Ink

When the ink level is below the lower line on an ink tank, you need to refill it.

Before checking the ink level or refilling an ink tank as described here, be sure to read the ink safety precautions.

Caution: If the ink level is below the lower line on the ink tank, fill it to the upper line on the ink tank. Continued use of the product when the ink level is below the lower line on the tank could damage the product.

[Ink Safety Precautions](#)

[Check Ink Levels](#)

[Purchase Epson Ink](#)

[Refilling the Ink Tanks](#)

Ink Safety Precautions

Ink Handling Precautions

- Keep ink bottles and the ink tank unit out of the reach of children. Do not allow children to drink from or handle the ink bottles and bottle caps.
- Do not tilt or shake an ink bottle after removing its seal; otherwise, ink may leak.
- If ink gets on your skin, wash it thoroughly with soap and water. If ink gets into your eyes, flush them immediately with water. If ink gets into your mouth, spit it out immediately. Seek medical advice if problems persist.

Ink Refilling Precautions

- Use ink bottles with the correct part number for this product.
- Do not mix with other Epson ink types.
- The use of non-Epson ink may cause damage that is not covered by Epson's warranty, and under certain circumstances, may cause erratic product behavior.
- This product requires careful handling of ink. Ink may splatter when the ink tanks are filled or refilled with ink. If ink gets on your clothes or belongings, it may not come off.

- Do not open the ink bottle package until you are ready to fill an ink tank. Ink bottles are vacuum packed to maintain reliability. If you leave an ink bottle unpacked for a long time before using it, print quality may be affected.
- If the ink level is below the lower line on the ink tank, refill the ink soon. Continued use of the product when the ink level is below the lower line on the ink tank could damage the product.
- After bringing an ink bottle inside from a cold storage site, allow it to warm up at room temperature for at least three hours before using it.
- Store ink bottles in a cool, dark place.
- Store the ink bottles in the same environment as the product. When storing or transporting an ink bottle after removing its seal, do not tilt the bottle and do not subject it to impacts or temperature changes. Otherwise, ink may leak even if the cap on the ink bottle is tightened securely. Be sure to keep the ink bottle upright when tightening the cap, and take measures to prevent ink from leaking when you transport the bottle.

Ink Bottle and Ink Tank Information

- To maintain optimum print head performance, some ink is consumed from all ink tanks during printing and when performing maintenance operations, such as cleaning the print head.
- The ink bottles may contain recycled materials, but this does not affect product function or performance.
- When printing in monochrome or grayscale, color ink may be used instead of black ink, depending on the paper type or print quality settings. This is because a mixture of color inks is used to create black.

Parent topic: [Refilling Ink](#)

Check Ink Levels

To confirm the actual ink remaining, visually check the ink levels in the product's ink tanks. Make sure the ink levels are above the lower lines on the ink tanks.

Caution: If the ink level is below the lower line on the ink tank, fill it to the upper line on the ink tank. Continued use of the product when the ink level is below the lower line on the tank could damage the product.

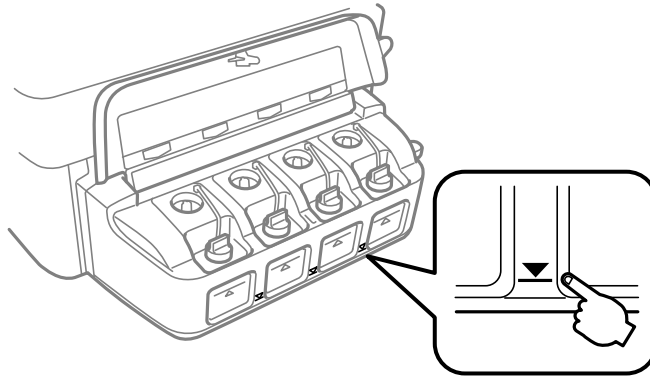

[Disabling Special Offers with Windows](#)

Parent topic: [Refilling Ink](#)

Related references

[Ink Safety Precautions](#)

Related tasks

[Refilling the Ink Tanks](#)

Disabling Special Offers with Windows

You can disable special offers messages from Epson using a utility on your Windows computer.

1. Right-click the product icon in the Windows taskbar and select **Monitoring Preferences**.

You see this window:

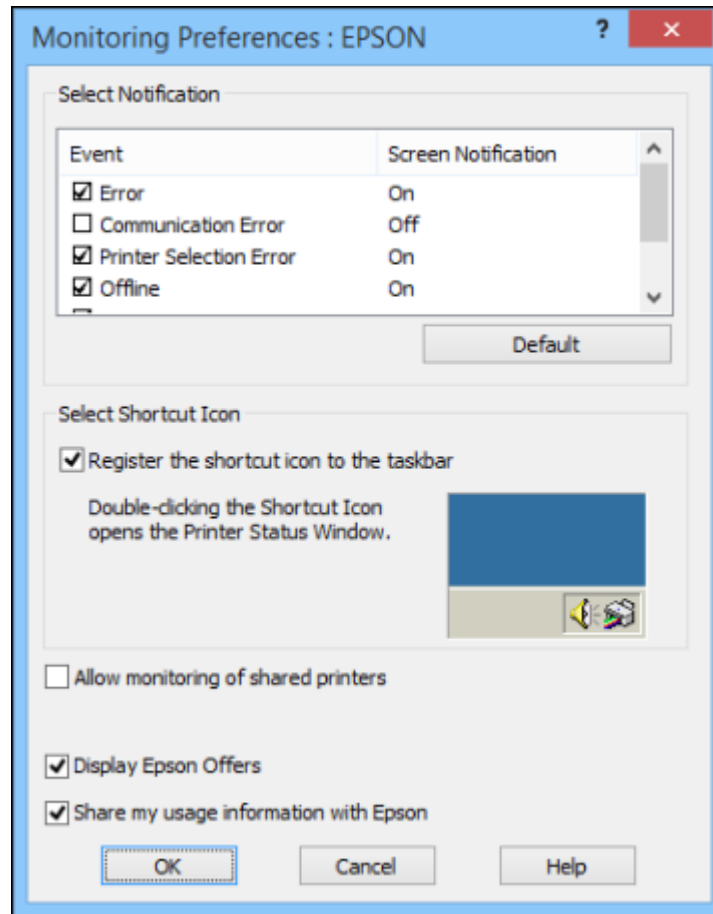

2. To disable promotional offers, deselect the **Display Epson Offers** checkbox.

Parent topic: [Check Ink Levels](#)

Purchase Epson Ink

You can purchase genuine Epson ink and paper at epson.com/ink3 (U.S. sales) or epson.ca (Canadian sales). You can also purchase supplies from an Epson authorized reseller. To find the nearest one, call 800-GO-EPSON (800-463-7766).

Note: This product is designed to work with genuine Epson inks. Non-Epson ink or any other ink not specified for this printer could cause damage not covered by Epson's warranties.

The included initial ink bottles must be used for printer setup and are not for resale. The printer ships with full ink bottles and part of the ink from the first bottles is used to charge the print head. Yields vary considerably based on images printed, print settings, paper type, frequency of use and temperature.

[Ink Bottle Part Numbers](#)

Parent topic: [Refilling Ink](#)

Ink Bottle Part Numbers

Use these part numbers when you order or purchase new ink bottles, and use the ink by the date printed on the package:

Ink color	Part number
Black	664
Cyan	664
Magenta	664
Yellow	664

Parent topic: [Purchase Epson Ink](#)

Refilling the Ink Tanks

Make sure you have new ink bottles handy and have read the ink safety precautions before you begin.

Caution: Wear disposable gloves while refilling the ink tanks to avoid staining your hands. If ink spills, wipe it off immediately with a damp towel to avoid permanent stains. If ink gets on your clothes or other items, it may not come off.

1. Place a sheet of paper under the ink tank unit, as ink may splatter.

2. Open the ink tank unit cover, then remove the ink tank cap and place it in the holder shown here.

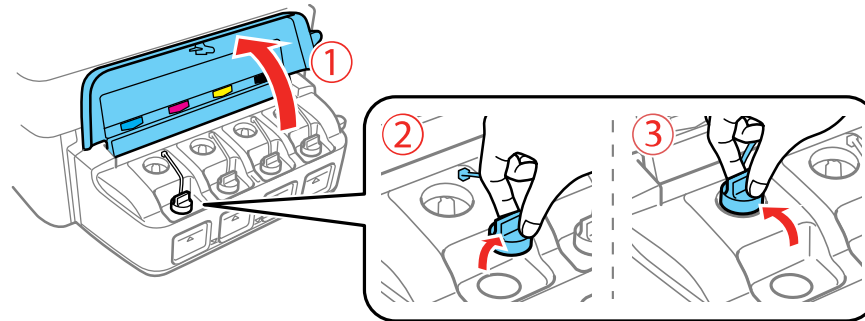

Note: Make sure the color of the ink tank label matches the ink color you want to refill, and only remove the cap from that ink tank. Be careful not to spill any ink.

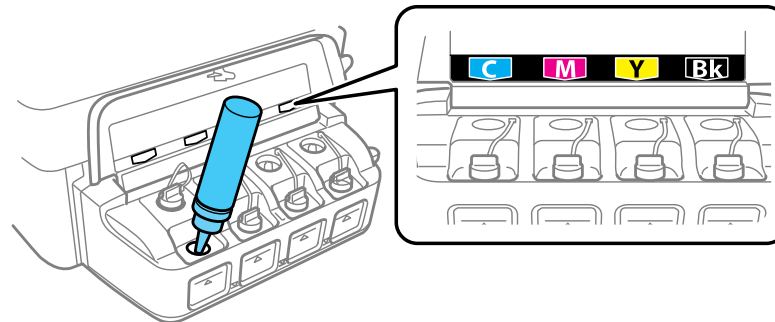

3. Snap off the tip of the bottle cap, but do not dispose of it so you can use it to seal the bottle cap later, if necessary. Then remove the bottle cap and carefully remove the protective seal (avoid touching the ink underneath the seal). Close the bottle cap tightly.

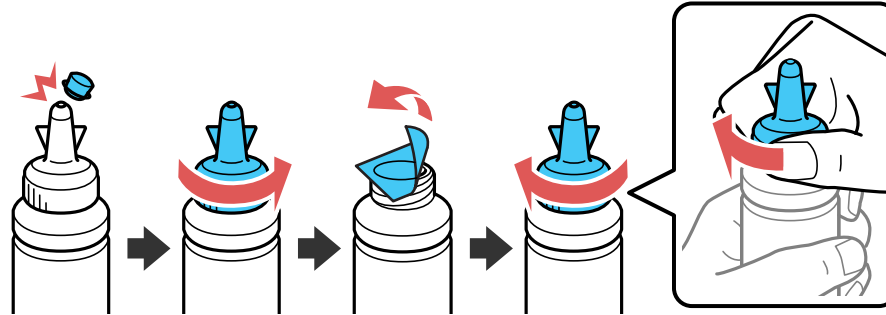

Caution: Close the bottle cap tightly; otherwise, ink may leak.

Warning: If ink gets on your skin, wash it thoroughly with soap and water. If ink gets into your eyes, flush them immediately with water. If ink gets into your mouth, spit it out immediately. Seek medical advice if problems persist. Keep the ink bottles out of the reach of children and do not drink the ink.

4. Refill the ink tank with the correct color ink up to the upper line on the ink tank.

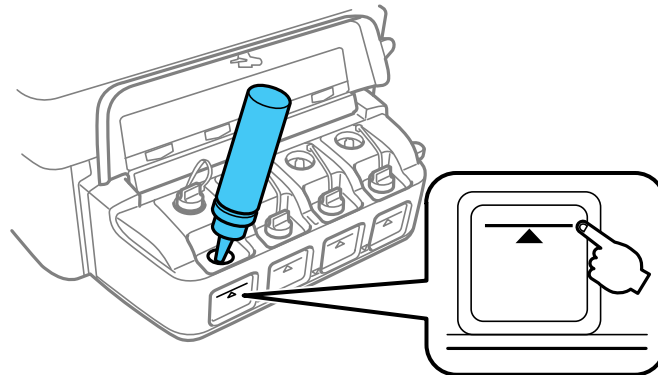

5. If any ink remains in the ink bottle after filling the ink tank, place the bottle cap tip securely on the bottle cap and store the ink bottle upright for later use.

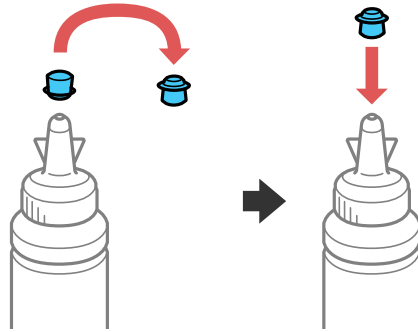

6. Replace the ink tank cap securely.

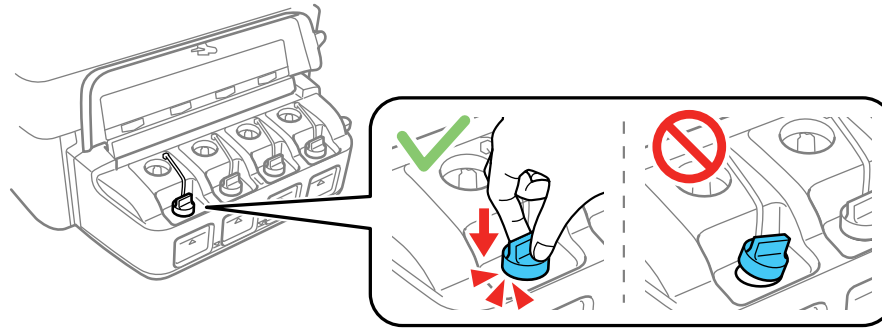

7. Repeat the previous steps as necessary for each ink tank you need to refill.

8. Close the ink tank unit cover.

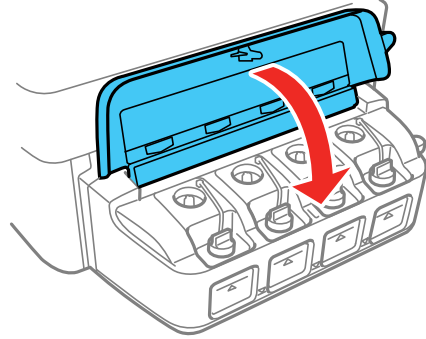

Parent topic: [Refilling Ink](#)

Related concepts

[Purchase Epson Ink](#)

Related references

[Ink Safety Precautions](#)

Adjusting Print Quality

If your print quality declines, you may need to run a utility to clean or align the print head.

If running these utilities does not solve the problem, you may need to flush the ink tubes.

[Print Head Maintenance](#)

[Print Head Alignment](#)

[Cleaning the Paper Path](#)

[Checking the Number of Sheets](#)

Print Head Maintenance

If your printouts become too light, or you see dark or light bands across them, you may need to clean the print head nozzles. Cleaning uses ink, so clean the nozzles only if print quality declines.

You can check for clogged nozzles before you clean them so you don't clean them unnecessarily.

Note: You may not be able to clean the print head when the ink level in any of the tanks is low. You may have to refill the ink tank first.

[Print Head Nozzle Check](#)

[Print Head Cleaning](#)

[Power Ink Flushing](#)

Parent topic: [Adjusting Print Quality](#)

Related tasks

[Refilling the Ink Tanks](#)

Print Head Nozzle Check

You can print a nozzle check pattern to check for clogged nozzles.

[Checking the Nozzles Using the Product Buttons](#)

[Checking the Nozzles Using a Computer Utility](#)

Parent topic: [Print Head Maintenance](#)

Checking the Nozzles Using the Product Buttons

You can check the print head nozzles using the buttons on your product.

1. Press the  power button to turn the product off.

2. Load a few sheets of plain paper in the product.
3. Hold down the ⏹ stop button and press the ⏻ power button to turn the product on.
4. When the product turns on, release both buttons.
The product begins printing a nozzle check pattern.
5. Check the printed pattern to see if there are gaps in the lines.

Print head is clean

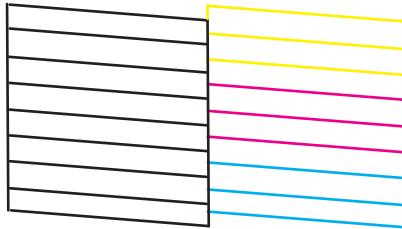

Print head needs cleaning

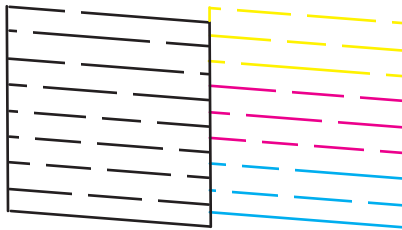

6. If there are no gaps, the print head is clean and you can continue printing.
If there are gaps or the pattern is faint, clean the print head.

Parent topic: [Print Head Nozzle Check](#)

Related tasks

[Loading Paper in the Sheet Feeder](#)

[Cleaning the Print Head Using the Product Buttons](#)

[Refilling the Ink Tanks](#)

Checking the Nozzles Using a Computer Utility

You can check the print head nozzles using a utility on your Windows or Mac computer.

1. Load a few sheets of plain paper in the product.
2. Do one of the following:
 - **Windows:** Access the Windows Desktop and right-click the product icon in the Windows taskbar.
 - **OS X:** In the Apple menu or the Dock, select **System Preferences**. Select **Print & Fax**, **Print & Scan**, or **Printers & Scanners**, select your product, and select **Options & Supplies**. Select **Utility** and select **Open Printer Utility**.
3. Select **Nozzle Check**.

You see a window like this:

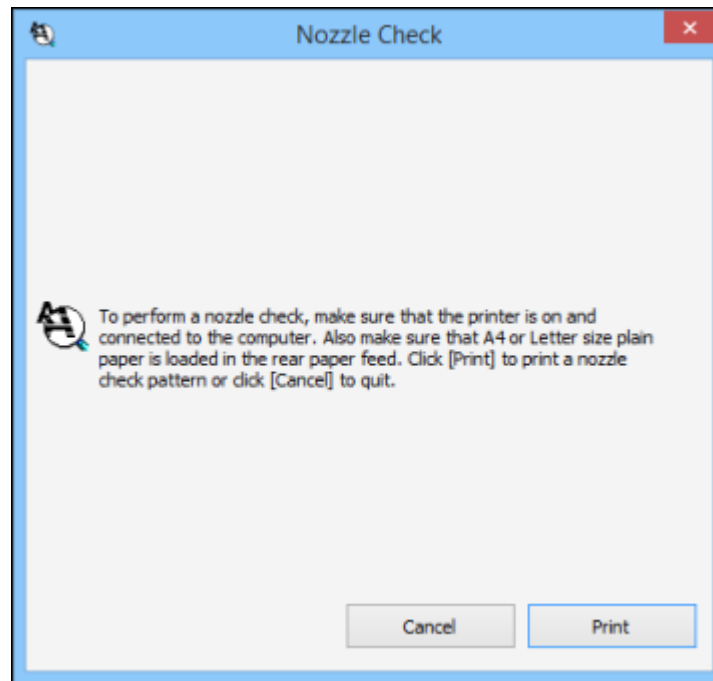

4. Click **Print**.

5. Check the printed pattern to see if there are gaps in the lines.

Print head is clean

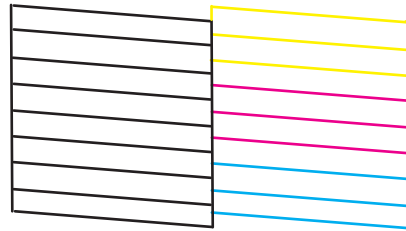

Print head needs cleaning

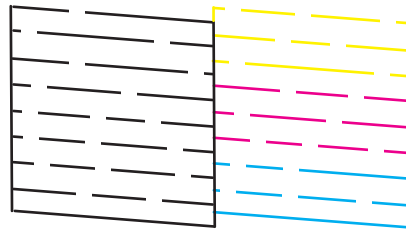

6. If there are no gaps, click **Finish**.

If there are gaps or the pattern is faint, clean the print head.

Parent topic: [Print Head Nozzle Check](#)

Related tasks

[Loading Paper in the Sheet Feeder](#)

[Cleaning the Print Head Using a Computer Utility](#)

[Refilling the Ink Tanks](#)

Print Head Cleaning

If print quality has declined and the nozzle check pattern indicates clogged nozzles, you can clean the print head.

Note: You may not be able to clean the print head when the ink level in any of the tanks is low. You may have to refill the ink tank first.

[Cleaning the Print Head Using the Product Buttons](#)

[Cleaning the Print Head Using a Computer Utility](#)

Parent topic: [Print Head Maintenance](#)

Related tasks

[Refilling the Ink Tanks](#)

Cleaning the Print Head Using the Product Buttons

You can clean the print head using the buttons on your product.

1. Make sure no product lights are indicating errors.
2. Load a few sheets of plain paper in the product.
3. Hold down the  stop button for 3 seconds to start the cleaning cycle.

The  power light flashes throughout the cleaning cycle and stays on when the cleaning cycle is finished.

Caution: Never turn off the product or open the scanner unit during a cleaning cycle or you may not be able to print.

4. Run a nozzle check to confirm that the print head is clean.

If you don't see any improvement after cleaning the print head up to 3 times, turn off the product and wait at least 12 hours. Then check the print head nozzles and try cleaning the print head again, if necessary. If quality still does not improve, contact Epson.

Parent topic: [Print Head Cleaning](#)

Related references

[Where to Get Help](#)

Related tasks

[Loading Paper in the Sheet Feeder](#)

[Checking the Nozzles Using the Product Buttons](#)

Cleaning the Print Head Using a Computer Utility

You can clean the print head using a utility on your Windows or Mac computer.

1. Make sure no product lights are indicating errors.
2. Load a few sheets of plain paper in the product.

3. Do one of the following:
 - **Windows:** Access the Windows Desktop and right-click the product icon in the Windows taskbar.
 - **OS X:** In the Apple menu or the Dock, select **System Preferences**. Select **Print & Fax**, **Print & Scan**, or **Printers & Scanners**, select your product, and select **Options & Supplies**. Select **Utility** and select **Open Printer Utility**.
4. Select **Head Cleaning**.

You see a window like this:

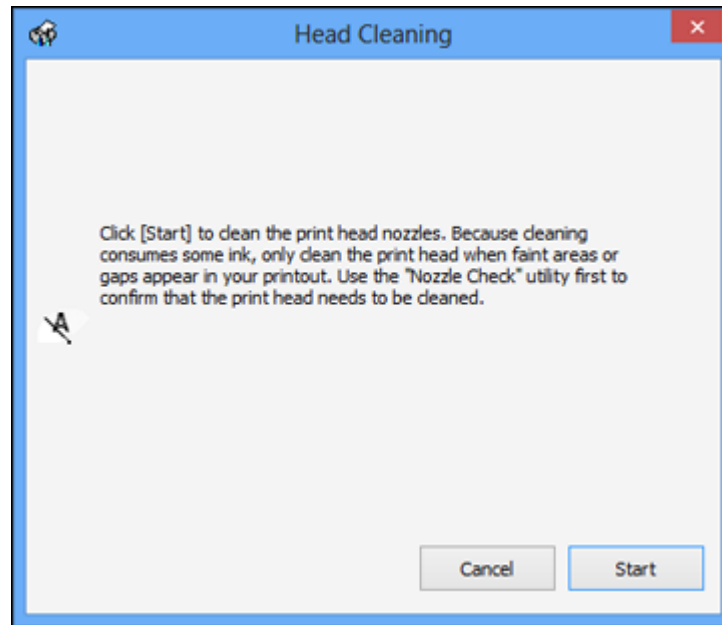

5. Click **Start** to begin the cleaning cycle.

The  power light flashes throughout the cleaning cycle and stays on when the cleaning cycle is finished.

Caution: Never turn off the product or open the scanner unit during a cleaning cycle or you may not be able to print.

- When the cleaning cycle is finished, you can check to see if the nozzles are clean; click **Print Nozzle Check Pattern** and click **Print**.
- Check the printed pattern to see if there are gaps in the lines.

Print head is clean

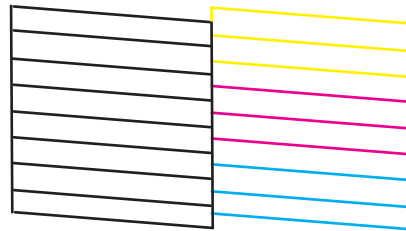

Print head needs cleaning

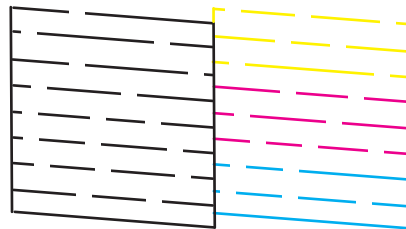

- If there are no gaps, click **Finish**.
- If there are gaps or the pattern is faint, click **Clean** to clean the print head again.

If you don't see any improvement after cleaning the print head up to 3 times, turn off the product and wait at least 12 hours. Then check the print head nozzles and try cleaning the print head again, if necessary. If quality still does not improve, contact Epson.

Parent topic: [Print Head Cleaning](#)

Related references

[Where to Get Help](#)

Related tasks

[Loading Paper in the Sheet Feeder](#)

[Checking the Nozzles Using a Computer Utility](#)

Power Ink Flushing

If you still see white or dark lines or missing colors in your printouts, even after cleaning the print head several times, you can perform a Power Ink Flushing.

Note: After a Power Ink Flushing, you must turn off the product and wait at least 12 hours before printing again.

Caution: Power Ink Flushing consumes a lot of ink and should be performed only if necessary. Refill the ink in the ink tanks before performing a Power Ink Flushing.

Power Ink Flushing affects the service life of the ink pads by causing them to reach their capacity sooner. When an ink pad reaches the end of its service life, the product stops printing and you must contact Epson for support.

[Flushing the Ink Using a Computer Utility](#)

Parent topic: [Print Head Maintenance](#)

Related tasks

[Refilling the Ink Tanks](#)

Flushing the Ink Using a Computer Utility

You can use the Power Ink Flushing utility to flush the ink.

Note: After a Power Ink Flushing, you must turn off the product and wait at least 12 hours before printing again.

Before you begin, make sure no product lights are indicating errors.

1. Do one of the following:
 - **Windows:** Access the Windows Desktop and right-click the product icon in the Windows taskbar and select **Printer Settings**. Then click the **Maintenance** tab.
 - **OS X:** In the Apple menu or the Dock, select **System Preferences**. Select **Print & Fax**, **Print & Scan**, or **Printers & Scanners**, select your product, and select **Options & Supplies**. Select **Utility** and select **Open Printer Utility**.
2. Click the **Power Ink Flushing** button.

You see a window like this:

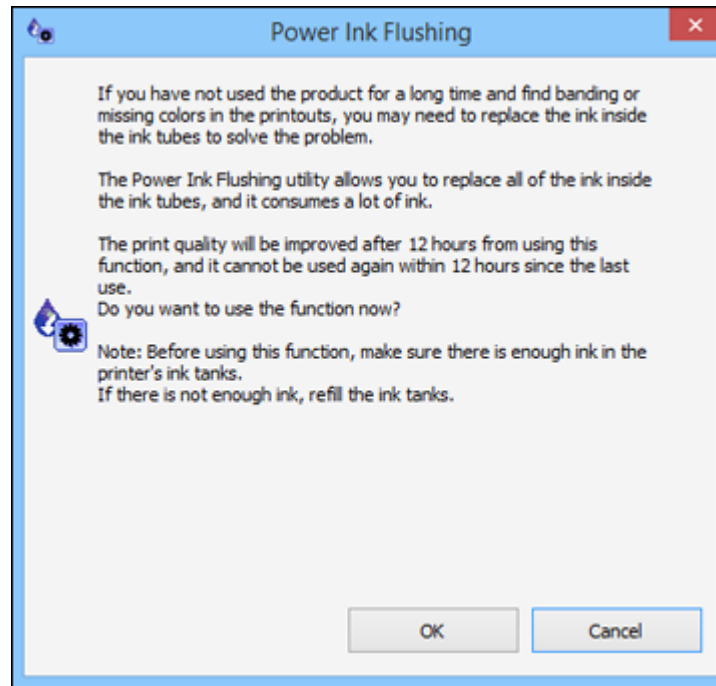

3. Follow the on-screen instructions.
4. When you finish the Power Ink Flushing, turn off the product and wait at least 12 hours before printing.
5. Print a document and check the print quality. If the print quality did not improve, contact Epson for support.

Parent topic: [Power Ink Flushing](#)

Related tasks

[Refilling the Ink Tanks](#)

Print Head Alignment

If your printouts become grainy or blurry, you notice misalignment of vertical lines, or you see dark or light horizontal bands, you may need to align the print head.

Note: Banding may also occur if your print head nozzles need cleaning.

[Aligning the Print Head Using a Computer Utility](#)

Parent topic: [Adjusting Print Quality](#)

Aligning the Print Head Using a Computer Utility

You can align the print head using a utility on your Windows or Mac computer.

1. Load a few sheets of plain paper in the product.
2. Do one of the following:
 - **Windows:** Access the Windows Desktop and right-click the product icon in the Windows taskbar.
 - **OS X:** In the Apple menu or the Dock, select **System Preferences**. Select **Print & Fax**, **Print & Scan**, or **Printers & Scanners**, select your product, and select **Options & Supplies**. Select **Utility** and select **Open Printer Utility**.
3. Select **Print Head Alignment**.
4. Click **Next**, then click **Print** to print an alignment sheet.

Note: Do not cancel printing while you are printing a head alignment pattern.

You see a window like this:

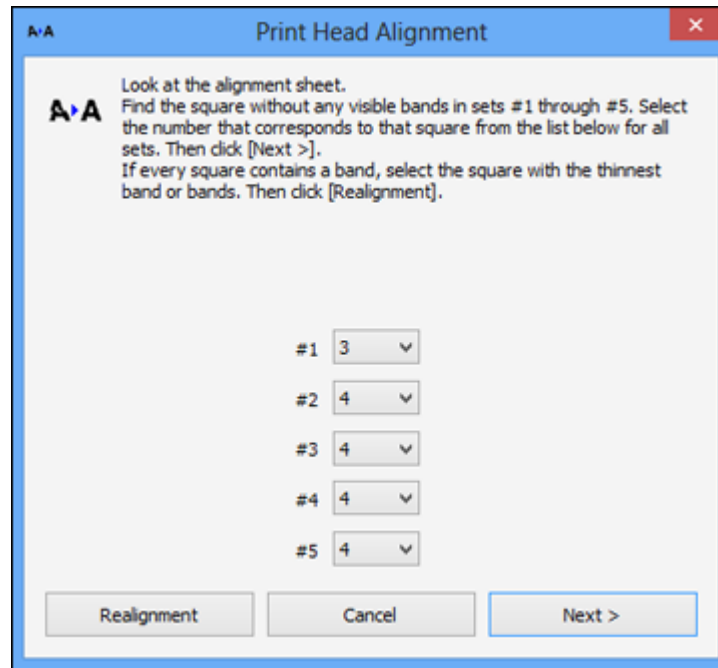

5. Check the printed pattern and follow the instructions on the screen to choose the number representing the best printed pattern for each set.

Vertical alignment

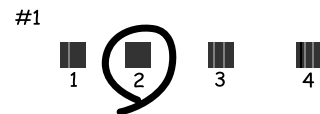

Horizontal alignment



- After choosing a pattern number, click **Next**.
- If no patterns are aligned in one or more of the sets, choose the closest one in each set and click **Realignment**. Then print another alignment sheet and check it.

Note: Click **Skip** (where available) if you want to skip a particular alignment sheet.

6. When you are done, click **Finish**.

Parent topic: [Print Head Alignment](#)

Related tasks

[Loading Paper in the Sheet Feeder](#)

Cleaning the Paper Path

If you see ink on the back of a printout, you can clean the paper path to remove any excess ink.

Caution: Do not use tissues to clean the rollers inside the product; lint from tissue may clog the print head nozzles.

1. Load a few sheets of plain paper in the product.
2. Use the product control panel to make a copy, but without placing a document on the scanner glass.

Note: Make sure there is no dust or stains on the scanner glass or document cover.

3. Check the back of the ejected paper to see if it is clean.
4. Repeat as necessary until the paper comes out clean.

Parent topic: [Adjusting Print Quality](#)

Related tasks

[Loading Paper in the Sheet Feeder](#)

Checking the Number of Sheets

You can view an option that displays the number of sheets of paper that have fed through the product.

[Checking the Sheet Counter - Windows](#)

[Checking the Sheet Counter - OS X](#)

Parent topic: [Adjusting Print Quality](#)

Checking the Sheet Counter - Windows

You can check the number of sheets of paper that have fed through the product by checking the sheet counter.

1. Access the Windows Desktop and right-click the product icon in the Windows taskbar.
2. Select **Printer Settings**.
3. Click the **Maintenance** tab.
4. Select **Printer and Option Information**.

You see this window:

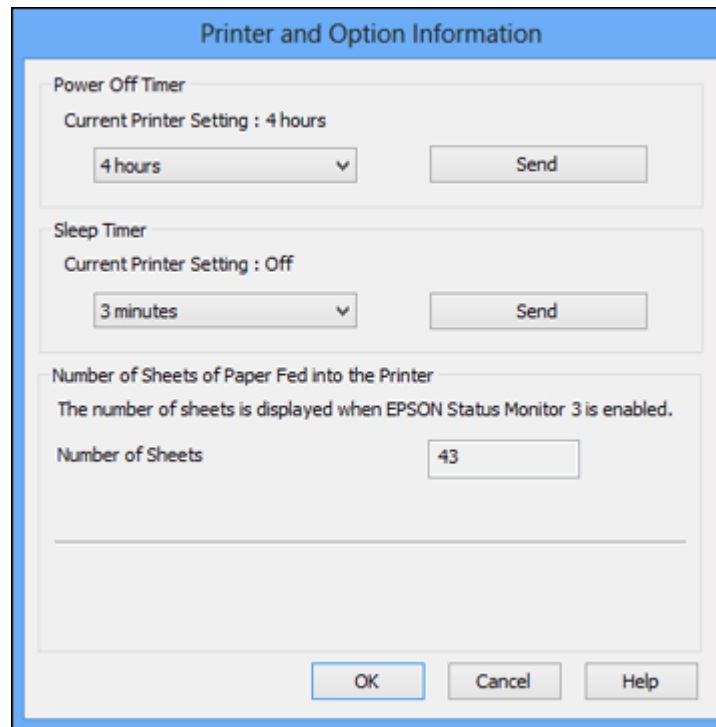

5. After checking the number of sheets fed into the printer, click **OK** to close the window.

Note: The number of sheets is displayed only when Epson Status Monitor 3 is enabled.

Parent topic: [Checking the Number of Sheets](#)

Checking the Sheet Counter - OS X

You can check the number of sheets of paper that have fed through the product by checking the sheet counter.

1. In the Apple menu or the Dock, select **System Preferences**. Select **Print & Fax**, **Print & Scan**, or **Printers & Scanners**, select your product, and select **Options & Supplies**. Select **Utility** and select **Open Printer Utility**.

2. Select **Printer and Option Information**.

You see this window:

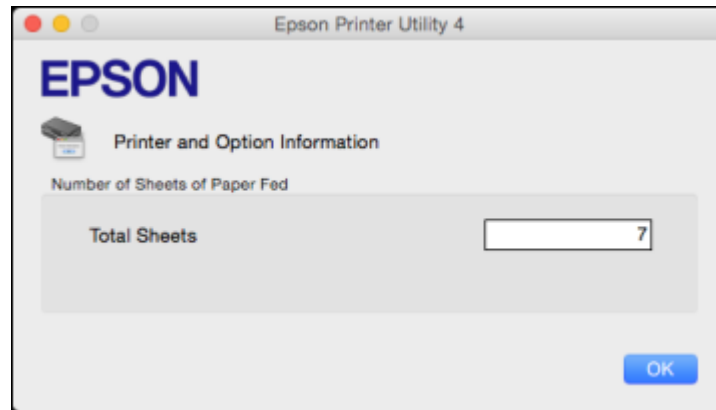

3. After checking the number of sheets fed into the printer, click **OK** to close the window.

Parent topic: [Checking the Number of Sheets](#)

Cleaning and Transporting Your Product

See these sections if you need to clean or transport your product.

[Cleaning Your Product](#)

[Transporting Your Product](#)

Cleaning Your Product

To keep your product working at its best, you should clean it several times a year.

Close the output tray and paper support when you are not using the product to protect it from dust.

Caution: Do not use a hard brush, alcohol, or paint thinner to clean the product or you may damage it. Do not use oil or other lubricants inside the product or let water get inside it.

1. Turn off the product.
2. Unplug the power cable.
3. Disconnect any connected cables.
4. Remove all the paper.
5. Clean the scanner glass with a soft, lint-free cloth (microfiber is recommended), moistened with a little glass cleaner.

Caution: Do not spray glass cleaner directly on the glass and do not press the glass surface with any force.

6. Clean the outer case and control panel with a soft, dry cloth. Do not use liquid or chemical cleansers.

Parent topic: [Cleaning and Transporting Your Product](#)

Transporting Your Product

If you need to store your product or transport it some distance, prepare it for transportation as described here.

Caution: During transportation and storage, follow these guidelines:

- Avoid tilting the product, placing it vertically, or turning it upside down; otherwise ink may leak.

- When storing or transporting an ink bottle after removing its seal, do not tilt the bottle and do not subject it to impacts or temperature changes. Otherwise, ink may leak even if the cap on the ink bottle is tightened securely. Be sure to keep the ink bottle upright when tightening the cap, and take measures to prevent ink from leaking when transporting the ink bottles.
- Do not put opened ink bottles in the box with the printer.
- Do not carry the product by its control panel; this may damage the product.

Note: Before storing your product for a long period, replace low, expended, or expired ink to help prevent the print head from drying out. Store your product in a cool, dry place.

1. Turn off the product.
2. Lift up the scanner unit and check to see if the print head is in the far right position (the home position). If not, turn on the product, wait for the print head to move to the far right, then turn the product off again.
3. Secure the print head to the case with tape.

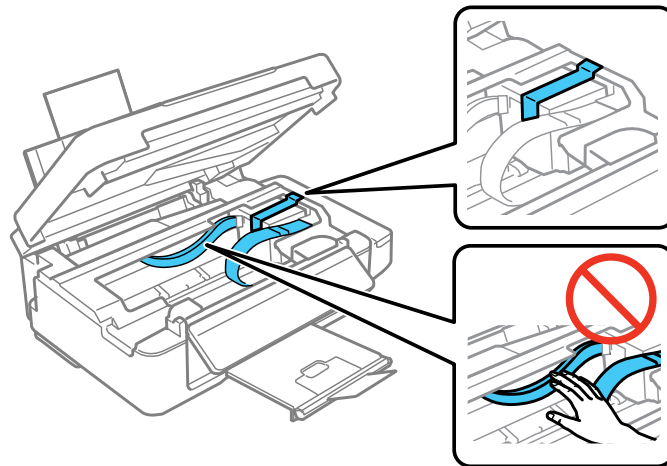

Caution: Do not place tape on the white flat cable inside the product; otherwise, you may damage your product.

4. Lower the scanner unit.
5. Remove all the paper from the product.

6. Unplug the power cable.
7. Disconnect any connected cables.
8. Close the paper support, feeder guard, and output tray. Then lower the control panel by squeezing the release bar and gently pushing the panel down.

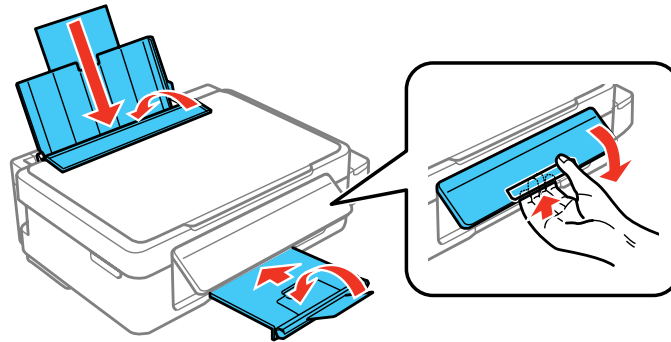

Caution: Do not lower the control panel without first squeezing the release bar or you may damage your product.

9. Open the ink tank unit cover and check to make sure that the ink tank caps are installed securely.

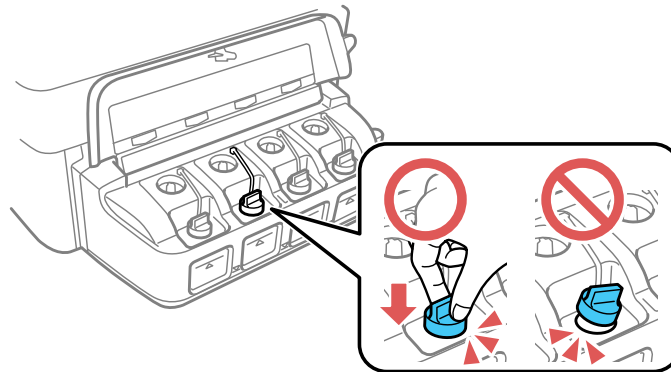

10. Place the product in the plastic bag that was included with the product and fold the bag closed as shown.

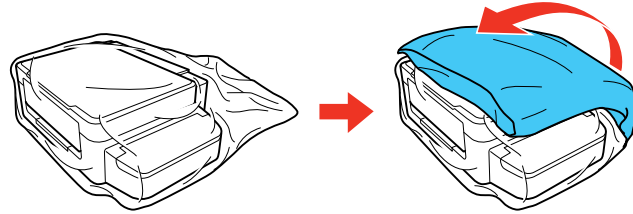

11. Place the product in its original packaging materials, if possible, or use equivalent cushioning around the product.

Caution: Keep the product level during transport. Otherwise, ink may leak.

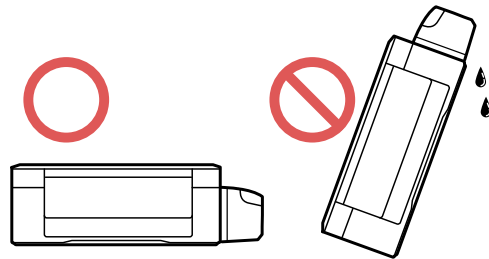

Be sure to remove the tape from the print head before turning on your product. If print quality has declined when you print again, clean and align the print head.

Parent topic: [Cleaning and Transporting Your Product](#)

Related concepts

[Print Head Cleaning](#)

Related tasks

[Aligning the Print Head Using a Computer Utility](#)

Solving Problems

Check these sections for solutions to problems you may have using your product.

[Checking for Software Updates](#)

[Product Light Status](#)

[Running a Product Check](#)

[Solving Setup Problems](#)

[Solving Network Problems](#)

[Solving Copying Problems](#)

[Solving Paper Problems](#)

[Solving Problems Printing from a Computer](#)

[Solving Page Layout and Content Problems](#)

[Solving Print Quality Problems](#)

[Solving Scanning Problems](#)

[Solving Scanned Image Quality Problems](#)

[Uninstall Your Product Software](#)

[Where to Get Help](#)

Checking for Software Updates

Periodically, it's a good idea to check Epson's support website for free updates to your product software. You can select **Download the Latest Software** from the Home screen of this manual or visit Epson's driver download site ([U.S. downloads](#) or [Canadian downloads](#)).

- **Windows:** Your printer software automatically checks for updates. You can also manually update the software by selecting **Software Update** here:
 - Accessing the Windows Desktop and right-clicking the product icon in the Windows taskbar
 - On the **Maintenance** tab in the printer settings window

You can also update the software by selecting **EPSON Software Updater** in the **EPSON** or **EPSON Software** program group, accessible by the **Start** button, or on the **Start** or **Apps** screens, depending on your version of Windows.

- **OS X:** You can manually update the software by opening the **Applications > Epson Software** folder and selecting **EPSON Software Updater**.

Parent topic: [Solving Problems](#)

Related tasks

[Changing Automatic Update Options](#)





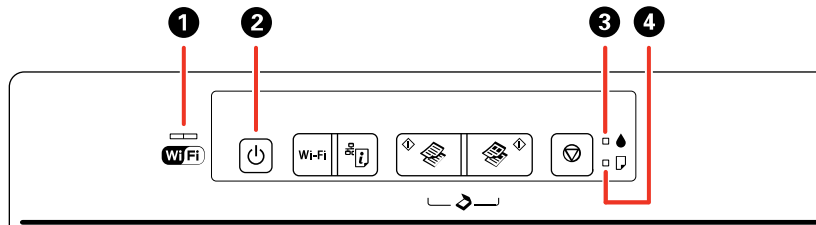



Product Light Status

You can often diagnose problems with your product by checking its lights.



Lights	
1	WiFi
2	⏻ power
3	💧 ink
4	📄 paper

Light status	Condition/solution
The ⏻ power light is on	The product is turned on.
The ⏻ power light is flashing	The product is busy. Wait for the ⏻ power light to stop flashing before turning off the product.
The ⏻ power light is on The 💧 ink light is on	Initial ink charging may not be complete. See the <i>Start Here</i> sheet for instructions.
The 📄 paper light is on	No paper is loaded or multiple sheets fed at one time. Load paper in the product, and press the 🖨️ B&W copy button or the 🖨️ color copy button to clear the error.
The 📄 paper light is flashing	Paper is jammed in the product. Remove the jammed paper, and press the 🖨️ B&W copy button or the 🖨️ color copy button to clear the error.

Light status	Condition/solution
The  power light is flashing The  paper light is flashing	An ink pad is nearing or at the end of its service life. Contact Epson for support. If a message to continue printing appears on your computer, press the  B&W copy button or the  color copy button to continue printing.
The  power light is flashing The  ink light is flashing The  paper light is flashing The WiFi light is flashing green and orange	Open the scanner unit and remove any paper or protective materials inside the printer. Turn the product off and then back on again.
The WiFi light is flashing orange	A WiFi error has occurred. Press the Wi-Fi button to clear the error and try again.
The  ink light is flashing The  paper light is flashing The WiFi light is flashing green and orange	An error has occurred during firmware updating. Connect your product using a USB cable and try updating the firmware again. If the error continues, contact Epson for support.

Note: The ink pads in the printer collect, distribute, and contain the ink that is not used on printed pages. During the life of your product it may reach a condition where either satisfactory print quality cannot be maintained or the ink pads have reached the end of their usable life. The Epson Status Monitor, your LCD screen, or lights on the control panel will advise you when these parts need replacing. If this happens during the standard warranty of the product, the exchange of the product or replacement of the pads is covered under the standard warranty. If the product is out of warranty, the pads can be replaced by any Epson authorized service provider. The waste ink pads are not a user-replaceable part.

Parent topic: [Solving Problems](#)

Related references

[Paper Jam Problems Inside the Product](#)

[Where to Get Help](#)

Related tasks

[Loading Paper in the Sheet Feeder](#)

Running a Product Check

Running a product check helps you determine if your product is operating properly.

1. Press the ⏻ power button to turn off the product.
2. Disconnect any interface cables connected to your product.
3. Load plain paper in the product.
4. Hold down the ⏹ stop button and press the ⏻ power button to turn on the product.
5. When the product turns on, release both buttons.

The product begins printing a nozzle check pattern.

6. Do the following, depending on the results of the product check:
 - If the page prints and the nozzle check pattern is complete, the product is operating properly. Any operation problem you may have could be caused by your computer, cable, software, or selected settings. Check the other solutions in this manual or try uninstalling and reinstalling your printer software.
 - If the page prints but the nozzle check pattern has gaps, clean or align the print head.
 - If the page does not print, the product may have a problem. Check other available solutions. If they do not work, contact Epson.

Parent topic: [Solving Problems](#)

Related concepts

[Print Head Cleaning](#)

[Uninstall Your Product Software](#)

Related references

[Where to Get Help](#)

Related tasks

[Aligning the Print Head Using a Computer Utility](#)

Solving Setup Problems

Check these sections if you have problems while setting up your product.

[Noise After Filling the Ink](#)

[Software Installation Problems](#)

[USB Connection Problems](#)

Parent topic: [Solving Problems](#)

Noise After Filling the Ink

If you hear noises from your product after filling the ink tanks with ink, check these explanations:

- The first time you fill the tanks with ink, the product must charge its print head. Wait until charging finishes before you turn off the product, or it may charge improperly and use excess ink the next time you turn it on.
- If the product's print head stops moving or making noise, and the charging process has not finished after approximately 20 minutes, turn off your product. Turn it back on and check to see if charging is still in progress. If it is still in progress, contact Epson for help.

Parent topic: [Solving Setup Problems](#)

Related topics

[Refilling Ink](#)

Software Installation Problems

If you have problems while installing your product software, try these solutions:

- Make sure your product is turned on and any necessary cables are securely connected at both ends. If you still have problems installing software, disconnect the cable and carefully follow the instructions on the *Start Here* sheet. Also make sure your system meets the requirements for your operating system.
- Close any other programs, including screen savers and virus protection software, and install your product software again.
- In Windows, make sure your product is selected as the default printer and the correct port is shown in the printer properties.
- If you see any error message or your software does not install correctly in Windows, you may not have software installation privileges. Contact your System Administrator.

Parent topic: [Solving Setup Problems](#)

Related concepts

[Uninstall Your Product Software](#)

Related references

[Windows System Requirements](#)

[OS X System Requirements](#)

USB Connection Problems

If you used a USB cable to connect to a computer that has multiple peripherals, make sure the computer is grounded. Otherwise, you may feel a slight electric shock when touching your product.

Parent topic: [Solving Setup Problems](#)

Solving Network Problems

Check these solutions if you have problems setting up or using your product on a network.

Note: Breakdown or repair of this product may cause loss of network data and settings. Epson is not responsible for backing up or recovering data and settings during or after the warranty period. We recommend that you make your own backup or print out your network data and settings.

[Product Cannot Connect to a Wireless Router or Access Point](#)

[Network Software Cannot Find Product on a Network](#)

[Product Does Not Appear in OS X Printer Window](#)

[Cannot Print Over a Network](#)

[Cannot Scan Over a Network](#)

Parent topic: [Solving Problems](#)

Product Cannot Connect to a Wireless Router or Access Point

If your product has trouble finding or connecting to a wireless router or access point, try these solutions:

- If you are connecting the product via Wi-Fi Protected Setup (WPS) and the WiFi light on your product is not solid green, make sure you press the **Wi-Fi** button on the product within 2 minutes of pressing the WPS button on your router. Hold down the **Wi-Fi** button on the product for 3 seconds.
- Make sure to place your product within contact range of your 2.4 GHz router or access point. Avoid placing your product near a microwave oven, 2.4 GHz cordless phone, or large metal object, such as a filing cabinet.

Note: If you are using a 5 GHz wireless router, set the router to operate in dual band (2.4 GHz and 5 GHz) mode. See your router documentation for instructions.

- Verify that your router or access point is operating correctly by connecting to it from your computer or another device.
- You may need to disable the firewall and any anti-virus software on your wireless router or access point.

- Check to see if access restrictions, such as MAC address filtering, are set on the router or access point. If access restrictions are set, add your product's MAC address to your router's address list. To obtain your product's MAC address, print a network status sheet. Then follow the instructions in your router or access point documentation to add the address to the list.
- If your router or access point does not broadcast its network name (SSID), follow the instructions that came with your product to enter your wireless network name manually.
- If your router or access point has security enabled, determine the kind of security it is using and any required password or passphrase for connection. Then make sure to enter the exact WEP key or WPA passphrase correctly.
- Check if your computer is restricting the available wireless channels. If so, verify that your wireless access point is using one of the usable channels and change to a usable channel, if necessary.

Parent topic: [Solving Network Problems](#)

Related tasks

[Using WPS to Connect to a Network](#)

[Printing a Network Status Sheet](#)

Related topics

[Wi-Fi Networking](#)

Network Software Cannot Find Product on a Network

If EpsonNet Setup cannot find your product on a network, try these solutions:

- Make sure your product is turned on and connected to your network. Verify connection using your product control panel.
- Check if your network name (SSID) contains non-ASCII characters. Your product cannot display non-ASCII characters.
- Make sure your product is not connected to a guest network.
- If necessary, reinstall your product software and try running EpsonNet Setup again:
 1. Reset your product's network settings to their factory defaults.
 2. Windows only: uninstall your product software.
 3. Initialize your router following the instructions in your router documentation.

Note: If you are reading these instructions online, you will lose your Internet connection when you initialize your router, so note the next step before initializing it.

4. Download your product software from the Epson website using the instructions on the *Start Here* sheet.
- If you have replaced your router, reinstall your product software to connect to the new router.

Note: If you are using a 5 GHz wireless router, set the router to operate in dual band (2.4 GHz and 5 GHz) mode. See your router documentation for instructions.

Parent topic: [Solving Network Problems](#)

Related tasks

[Using WPS to Connect to a Network](#)

[Printing a Network Status Sheet](#)

[Connecting to a New Wi-Fi Router](#)

Related topics

[Wi-Fi Networking](#)

Product Does Not Appear in OS X Printer Window

If your product does not appear in the OS X printer window, try these solutions:

- Turn your product off, wait 30 seconds, then turn it back on again.
- If you are connecting the product via Wi-Fi Protected Setup (WPS) and the WiFi light on your product is not solid green, make sure you press the **Wi-Fi** button on the product within 2 minutes of pressing the WPS button on your router. Hold down the **Wi-Fi** button on the product for 3 seconds.
- If you are connecting the product wirelessly via EpsonNet Setup and the WiFi light on your product is not solid green, make sure your product software was installed correctly. If necessary, reinstall your software.

Note: If you are using a 5 GHz wireless router, set the router to operate in dual band (2.4 GHz and 5 GHz) mode. See your router documentation for instructions.

Parent topic: [Solving Network Problems](#)

Related tasks

[Using WPS to Connect to a Network](#)

[Printing a Network Status Sheet](#)

Related topics

[Wi-Fi Networking](#)

Cannot Print Over a Network

If you cannot print over a network, try these solutions:

- Make sure that your product is turned on.
- Make sure you install your product's network software as described in your product documentation.
- Print a network status sheet and verify that the network settings are correct. If the network status is **Disconnected**, check any cable connections and turn your product off and then on again.
- If you are using TCP/IP, make sure the product's IP address is set correctly for your network. If your network does not assign IP addresses using DHCP, set the IP address manually.
- Make sure your computer and product are both using the same wireless network.
- If network printing is slow, print a network status sheet and check the signal strength. If it is poor, place your product closer to your router or access point. Avoid placing your product near a microwave oven, 2.4 GHz cordless phone, or large metal object, such as a filing cabinet.

Note: If you are using a 5 GHz wireless router, set the router to operate in dual band (2.4 GHz and 5 GHz) mode. See your router documentation for instructions.

- Check to see if your wireless router or access point has an enabled Privacy Separator function that is preventing printing from a device over the network. See your router or access point documentation for instructions on disabling the Privacy Separator function.
- If you are connecting the product via Wi-Fi Protected Setup (WPS) and the WiFi light on your product is not solid green, make sure you press the **Wi-Fi** button on the product within 2 minutes of pressing the WPS button on your router. Hold down the WiFi button on the product for 3 seconds.
- If you are connecting the product via EpsonNet Setup and the WiFi light on your product is not solid green, make sure your product software was installed correctly. If necessary, reinstall your software.

Parent topic: [Solving Network Problems](#)

Related tasks

[Using WPS to Connect to a Network](#)

[Printing a Network Status Sheet](#)

Related topics

[Wi-Fi Networking](#)

Cannot Scan Over a Network

If you cannot start Epson Scan for scanning over a network, try these solutions:

- If you cannot scan from your product control panel, make sure you restarted your computer after installing the product software. Make sure the Event Manager program is not being blocked by your firewall or security software.

Note: If you are using a 5 GHz wireless router, set the router to operate in dual band (2.4 GHz and 5 GHz) mode. See your router documentation for instructions.

- If you are scanning a large original at a high resolution, a network communication error may occur. Try scanning again at a lower resolution.
- If network communication was interrupted while starting Epson Scan, exit Epson Scan, wait a few seconds, and restart it. If Epson Scan cannot restart, turn off your product, turn it back on, and try restarting Epson Scan again.
- Check the connection setting and test the connection using Epson Scan Settings:

Windows 8.x: Navigate to the **Apps** screen and select **EPSON Scan Settings**. Make sure the **Connection** setting is set to **Network**, then click the **Test** button.

Windows (other versions): Click  or **Start > All Programs** or **Programs > EPSON > EPSON Scan > EPSON Scan Settings**. Make sure the **Connection** setting is set to **Network**, then click the **Test** button.

OS X: Open the **Applications** folder, click **Epson Software**, and click **EPSON Scan Settings**. Make sure the **Connection** setting is set to **Network**, then click the **Test** button.

- Make sure the option selected as the **Timeout Setting** in the Epson Scan Settings program is long enough to complete scanning over a network.
- You may need to disable the firewall and any anti-virus software on your wireless router or access point.

Note: With OS X, in addition to scanning with Image Capture, you can download and install Epson Scan scanning software. Epson Scan provides additional image adjustment and photo correction features for enhancing scanned images, and provides an interface for TWAIN-compliant OCR scanning software. To download Epson Scan, visit Epson's driver download site ([U.S. downloads](#) or [Canadian downloads](#)).

Parent topic: [Solving Network Problems](#)

Related topics

[Wi-Fi Networking](#)

[Starting a Scan](#)

Solving Copying Problems

Check these solutions if you have problems copying with your product.

[Product Makes Noise, But Nothing Copies](#)

[Product Makes Noise When It Sits for a While](#)

Parent topic: [Solving Problems](#)

Product Makes Noise, But Nothing Copies

If your product makes a noise, but nothing copies, try these solutions:

- Run a nozzle check to see if any of the print head nozzles are clogged. Then clean the print head, if necessary.
- If the nozzle check page does not print, but the product's power is on, make sure your product software is installed correctly.
- Make sure your product is level (not tilted).

Parent topic: [Solving Copying Problems](#)

Related concepts

[Print Head Nozzle Check](#)

[Print Head Cleaning](#)

Product Makes Noise When It Sits for a While

Your product is performing routine maintenance. This is normal.

Parent topic: [Solving Copying Problems](#)

Solving Paper Problems

Check these sections if you have problems using paper with your product.

[Paper Feeding Problems](#)

[Paper Jam Problems Inside the Product](#)

[Paper Ejection Problems](#)

Parent topic: [Solving Problems](#)

Paper Feeding Problems

If you have problems feeding paper, try these solutions:

- If paper does not feed for printing, remove it. Then reload it in the sheet feeder against the right side and beneath the tab. Slide the edge guide against the edge of the paper, making sure that the paper stack is not above the arrow mark on the edge guide.
- If multiple pages feed at once, remove the paper, fan the edges to separate the sheets, and reload it.
- If paper jams when you load only one or two sheets, try loading more sheets at a time. Do not load more than the recommended number of sheets.
- If paper jams when you print on both sides of the paper, try loading fewer sheets.
- Make sure your paper meets the specifications for your product.
- For best results, follow these guidelines:
 - Use new, smooth, high-quality paper that is not curled, creased, old, too thin, or too thick.
 - Load paper in the sheet feeder printable side up.
 - Follow any special loading instructions that came with the paper.

Parent topic: [Solving Paper Problems](#)

Related references

[Paper Loading Capacity](#)

[Paper Jam Problems Inside the Product](#)

Related tasks

[Loading Paper in the Sheet Feeder](#)

Paper Jam Problems Inside the Product

If paper has jammed inside the product, follow the steps below to clear the jam.

1. Cancel the print job, if necessary.

2. Remove any jammed paper from the rear paper feed slot.

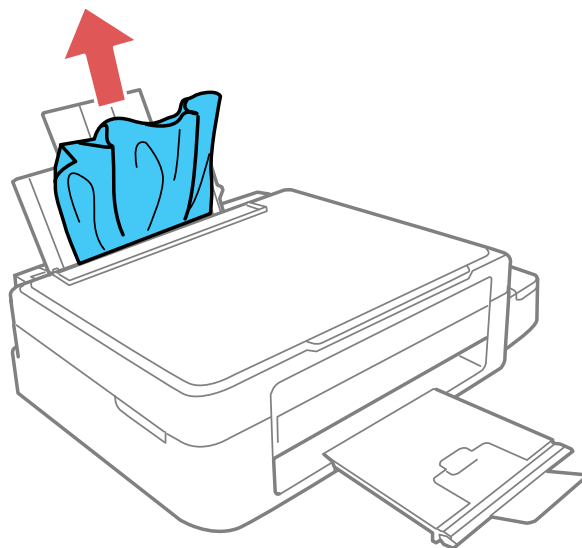

3. Lift the scanner unit.

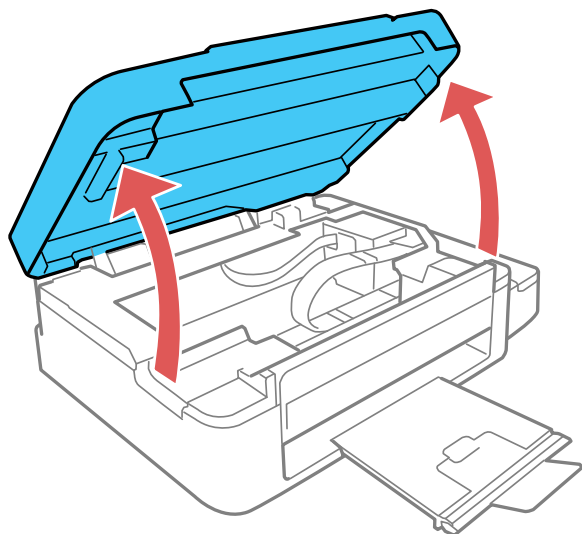

Caution: Do not touch the flat white cable inside the printer. Do not lift the scanner unit while the document cover is open.

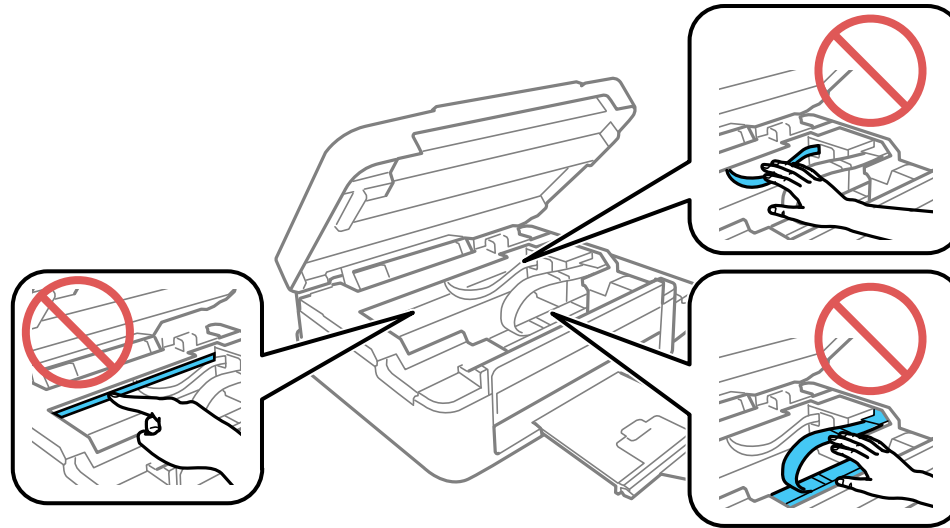

4. Remove any paper inside, including torn pieces.

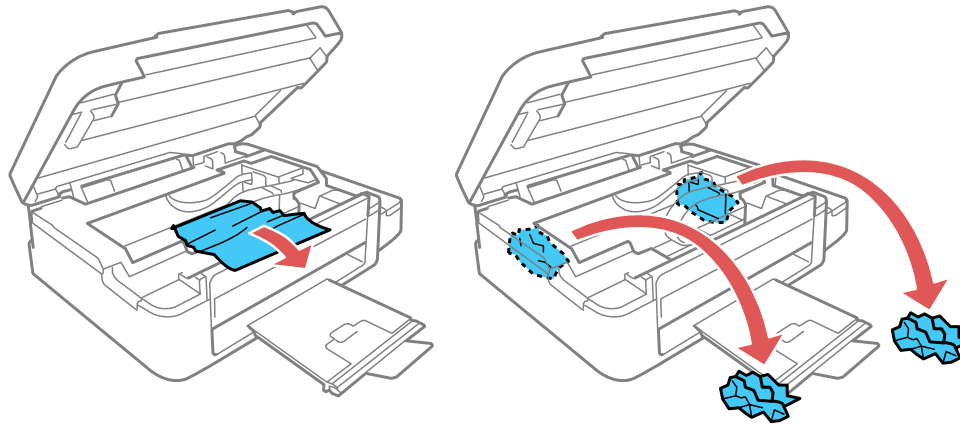

5. Close the scanner unit.

Parent topic: [Solving Paper Problems](#)

Related tasks

[Cancelling Printing Using a Product Button](#)

Paper Ejection Problems

If you have problems with paper ejecting properly, try these solutions:

- If paper does not eject fully, you may have set the wrong paper size. Cancel printing to eject the paper. Select the correct paper size when you reprint.
- If paper is wrinkled when it ejects, it may be damp or too thin. Load new paper and be sure to select the correct paper type setting when you reprint.

Parent topic: [Solving Paper Problems](#)

Related references

[Paper Jam Problems Inside the Product](#)

[Paper or Media Type Settings - Product Software](#)

Related tasks

[Loading Paper in the Sheet Feeder](#)

[Cancelling Printing Using a Product Button](#)

Solving Problems Printing from a Computer

Check these sections if you have problems while printing from your computer.

[Nothing Prints](#)

[Product Icon Does Not Appear in Windows Taskbar](#)

[Printing is Slow](#)

Parent topic: [Solving Problems](#)

Nothing Prints

If you have sent a print job and nothing prints, try these solutions:

- Make sure your product is turned on.
- Make sure any interface cables are connected securely at both ends.
- If you connected your product to a USB hub, make sure it is a first-tier hub. If it still does not print, connect your product directly to your computer instead of the hub.

- Run a product check to see if a test page prints. If the test page prints, check to see if your product software is installed correctly.
- If you are printing a large image, the computer may not have enough memory. Print the image at a lower resolution or a smaller file size.
- In Windows, click **Print Queue** on the Maintenance tab in the printer settings window and check for the following:
 - Check for any stalled or paused print jobs. Cancel or unpause any jobs as necessary.
 - Open the Printer menu and make sure the product is not offline.
 - Open the Printer menu and set the product as the default printer, if necessary.
- In OS X, select **System Preferences** from the Apple menu or Dock, select **Print & Scan** or **Printers & Scanners**, then double-click your printer icon. Check to see if any jobs are paused. Cancel or resume any jobs as necessary.



Parent topic: [Solving Problems Printing from a Computer](#)

Related tasks

[Running a Product Check](#)

Product Icon Does Not Appear in Windows Taskbar

If you do not see your product icon in the Windows taskbar, first try restarting your computer. If that does not work, try this solution:

1. Do one of the following:
 - **Windows 8.x:** Navigate to the **Apps** screen and select **Control Panel > Hardware and Sound > Devices and Printers**.
 - **Windows 7:** Click  and select **Devices and Printers**.
 - **Windows Vista:** Click , select **Control Panel**, and click **Printer** under **Hardware and Sound**.
 - **Windows XP:** Click **Start** and select **Printers and Faxes**. (Or open the **Control Panel**, select **Printers and Other Hardware**, if necessary, and **Printers and Faxes**.)
2. Right-click your product name, select **Printing Preferences**, and select your product name again if necessary.
3. Click the **Maintenance** tab.
4. Click the **Extended Settings** button.
5. Select **Enable EPSON Status Monitor 3**, then click **OK**.

6. Click the **Monitoring Preferences** button.
7. Click the checkbox for the option that adds the shortcut icon to the taskbar.
8. Click **OK** to close the open program windows.

Parent topic: [Solving Problems Printing from a Computer](#)

Printing is Slow

If printing becomes slow, try these solutions:

- Make sure your system meets the requirements for your operating system. If you are printing a high-resolution image, you may need more than the minimum requirements. If necessary, increase your system's memory.
- If you are using Windows 7, close the **Devices and Printers** window before you print.
- If you are using OS X, make sure you download and install the Epson printer driver.
- Make sure **Quiet Mode** is turned off.
- Clear space on your hard drive or run a defragmentation utility to free up existing space.
- Close any programs you are not using when you print.
- If your product is connected to a USB hub, connect it directly to your computer instead.
- If printing becomes slower after printing continuously for a long time, the product may have automatically slowed down to protect the print mechanism from overheating or becoming damaged. Let the product rest with the power on for 30 minutes, then try printing again.

For the fastest printing, select the following settings in your product software:

- Make sure the paper type setting matches the type of paper you loaded.
- Turn on any high speed settings in your product software.
- Select a lower print quality setting.
- **Windows:** Click the **Maintenance** or **Utility** tab, select **Extended Settings** or **Speed and Progress**, and select the following settings:
 - **Always Spool RAW Datatype**
 - **Page Rendering Mode**
 - **Print as Bitmap**

Parent topic: [Solving Problems Printing from a Computer](#)

Related references

[Windows System Requirements](#)

[OS X System Requirements](#)

[Paper or Media Type Settings - Product Software](#)

Related tasks

[Selecting Basic Print Settings - Windows](#)

[Selecting Extended Settings - Windows](#)

[Selecting Basic Print Settings - OS X](#)

[Selecting Printing Preferences - OS X](#)

Solving Page Layout and Content Problems

Check these sections if you have problems with the layout or content of your printed pages.

[Inverted Image](#)

[Too Many Copies Print](#)

[Blank Pages Print](#)

[Incorrect Margins on Printout](#)

[Incorrect Characters Print](#)

[Incorrect Image Size or Position](#)

[Slanted Printout](#)

Parent topic: [Solving Problems](#)

Inverted Image

If your printed image is inverted unexpectedly, try these solutions:

- Turn off any mirror or inversion settings in your printing application.
- Turn off the **Mirror Image**, **Flip horizontally**, or **Reverse page orientation** settings in your printer software. (This option has different names, depending on your operating system version.)

Note: Leave these options turned on when you print on Epson Iron-on Cool Peel Transfer paper, if available for your product.

Parent topic: [Solving Page Layout and Content Problems](#)

Related tasks

[Selecting Basic Print Settings - Windows](#)

Too Many Copies Print

Make sure that the **Copies** setting in your printing program or printer software is not set for multiple copies.

Parent topic: [Solving Page Layout and Content Problems](#)

Blank Pages Print

If blank pages print unexpectedly, try these solutions:

- Make sure you selected the correct paper size settings in your printing program and printer software.
- If a blank page exists in a document you are printing and you want to skip printing it, select the **Skip Blank Page** setting in your printer software.
- Run a print head nozzle check to see if any of the nozzles are clogged. Then clean the print head, if necessary.
- Make sure your product is selected as the printer in your printing program.
- You may need to refill the ink. Visually check the ink levels.

Parent topic: [Solving Page Layout and Content Problems](#)

Related concepts

[Print Head Nozzle Check](#)

[Print Head Cleaning](#)

Related tasks

[Selecting Basic Print Settings - Windows](#)

[Selecting Extended Settings - Windows](#)

[Selecting Basic Print Settings - OS X](#)

[Selecting Printing Preferences - OS X](#)

Incorrect Margins on Printout

If your printed page has incorrect margins, try these solutions:

- Make sure you selected the correct paper size settings in your printing program and printer software.
- Make sure you selected the correct margins for your paper size in your printing program.
- Make sure your paper is positioned correctly for feeding into the printer.

You can use the preview option in your printer software to check your margins before you print.

Parent topic: [Solving Page Layout and Content Problems](#)

Related tasks

[Loading Paper in the Sheet Feeder](#)

[Selecting Basic Print Settings - Windows](#)

[Selecting Basic Print Settings - OS X](#)

[Selecting Page Setup Settings - OS X](#)

Incorrect Characters Print

If incorrect characters appear in your prints, try these solutions before reprinting:

- Make sure any cables are securely connected at both ends.
- In Windows, delete all jobs from the Windows Spooler. Click **Print Queue** on the Maintenance tab in the printer settings window, and cancel any stalled print jobs.
- If your product is connected to a USB hub, connect it directly to your computer instead.
- If your computer entered sleep mode the last time you printed, the next print job after your computer exits sleep mode may contain garbled characters. Print your document again.
- If incorrect characters still appear in your prints, try connecting your product using a different cable.

Parent topic: [Solving Page Layout and Content Problems](#)

Related tasks

[Selecting Basic Print Settings - Windows](#)

[Selecting Basic Print Settings - OS X](#)

[Selecting Page Setup Settings - OS X](#)

Incorrect Image Size or Position

If your printed image is the wrong size or in the wrong position, try these solutions:

- Make sure you selected the correct paper size and layout settings in your printing program and printer software.
- Make sure your paper is positioned correctly for feeding into the printer.

You can use the preview option in your printer software to check your margins before you print.

Parent topic: [Solving Page Layout and Content Problems](#)

Related tasks

- [Loading Paper in the Sheet Feeder](#)
- [Selecting Basic Print Settings - Windows](#)
- [Selecting Basic Print Settings - OS X](#)
- [Selecting Page Setup Settings - OS X](#)

Slanted Printout

If your printouts are slanted, try these solutions:

- Slide the edge guide against the edge of the paper.
- Select a higher print quality setting in your printer software.
- Turn off any high speed settings in your product software.
- Align the print head.
- Make sure the product is not printing while tilted or at an angle.

Parent topic: [Solving Page Layout and Content Problems](#)

Related tasks

- [Loading Paper in the Sheet Feeder](#)
- [Selecting Basic Print Settings - Windows](#)
- [Selecting Basic Print Settings - OS X](#)

Solving Print Quality Problems

Check these sections if your printouts have problems with print quality, but your image looks fine on your computer screen.

- [White or Dark Lines in Printout](#)
- [Blurry or Smearred Printout](#)
- [Faint Printout or Printout Has Gaps](#)
- [Grainy Printout](#)
- [Incorrect Colors](#)

Parent topic: [Solving Problems](#)

White or Dark Lines in Printout

If you notice white or dark lines in your prints (also called banding), try these solutions before you reprint:

- Run a nozzle check to see if any of the print head nozzles are clogged. Then clean the print head, if necessary.
- Make sure the paper type setting matches the type of paper you loaded.
- Make sure you loaded the printable side of the paper correctly for your product.
- Turn off any high speed settings in your product software.
- Align the print head.
- You may need to refill the ink. Visually check the ink levels.
- If you have not used the product for a long time, run the Power Ink Flushing utility.

Note: Flushing the ink tubes replaces all the ink inside the tubes, so flush the ink only if you cannot improve print quality by other means. See the ink flushing section for details.

Parent topic: [Solving Print Quality Problems](#)

Related concepts

[Print Head Nozzle Check](#)

[Print Head Cleaning](#)

[Print Head Alignment](#)

[Power Ink Flushing](#)

Related references

[Paper or Media Type Settings - Product Software](#)

Related tasks

[Selecting Additional Layout and Print Options - Windows](#)

[Selecting Printing Preferences - OS X](#)

[Loading Paper in the Sheet Feeder](#)

Related topics

[Refilling Ink](#)

Blurry or Smearred Printout

If your printouts are blurry or smearred, try these solutions:

- Make sure your paper is not damp, curled, old, or loaded incorrectly in your product.
- Use a support sheet with special paper, or load special paper one sheet at a time.
- Make sure your paper meets the specifications for your product.
- Use Epson papers to ensure proper saturation and absorption of genuine Epson inks.
- Make sure the paper type setting in your product software matches the type of paper you loaded.
- Make sure you loaded the printable side of the paper correctly for your product.
- Remove each sheet from the output tray as it is printed.
- Avoid handling printouts on glossy paper right after printing to allow the ink to set.
- Turn off any high speed settings in your product software.
- If you print on both sides of a sheet of paper, smudges may appear on the reverse side of heavily saturated or dark images. If one side of a sheet will contain a lighter image or text, print that side first. Make sure the ink has dried before reloading the paper to print on the other side.
- Run a nozzle check to see if any of the print head nozzles are clogged. Then clean the print head, if necessary.
- Align the print head.
- Clean the paper path.
- If you have not used the product for a long time, run the Power Ink Flushing utility.

Note: Flushing the ink tubes replaces all the ink inside the tubes, so flush the ink only if you cannot improve print quality by other means. See the ink flushing section for details.

Note: Your product will not operate properly while tilted at an angle. Place it on a flat, stable surface that extends beyond the base of the product in all directions.

Parent topic: [Solving Print Quality Problems](#)

Related concepts

[Print Head Nozzle Check](#)

[Print Head Cleaning](#)

[Print Head Alignment](#)

Related references

[Available Epson Papers](#)
[Paper Specifications](#)

Related tasks

[Selecting Basic Print Settings - Windows](#)
[Selecting Additional Layout and Print Options - Windows](#)
[Selecting Extended Settings - Windows](#)
[Selecting Basic Print Settings - OS X](#)
[Selecting Printing Preferences - OS X](#)
[Cleaning the Paper Path](#)

Faint Printout or Printout Has Gaps

If your printouts are faint or have gaps, try these solutions:

- Run a nozzle check to see if any of the print head nozzles are clogged. Then clean the print head, if necessary.
- The ink levels may be low. Visually check the ink levels.
- Make sure the paper type setting matches the type of paper you loaded.
- Make sure your paper is not damp, curled, old, or loaded incorrectly in your product.
- Align the print head.
- Clean the paper path.

Parent topic: [Solving Print Quality Problems](#)

Related concepts

[Print Head Nozzle Check](#)
[Print Head Cleaning](#)
[Print Head Alignment](#)

Related references

[Paper or Media Type Settings - Product Software](#)

Related tasks

[Loading Paper in the Sheet Feeder](#)
[Cleaning the Paper Path](#)

Related topics

[Refilling Ink](#)

Grainy Printout

If your printouts are grainy, try these solutions:

- Make sure you loaded the printable side of the paper correctly for your product.
- Select a higher print quality setting and turn off any high speed settings in your product software.
- Run a nozzle check to see if any of the print head nozzles are clogged. Then clean the print head, if necessary.
- Align the print head.
- You may need to increase the image resolution or print a smaller size; see your software documentation.

Note: Images from the Internet may be low resolution and not result in a high quality printout.

- If you enlarged the image in an image-editing program, you need to increase the resolution setting to retain a high image quality. Increase the resolution by the same amount you increased the image size. For example, if the resolution is 300 dpi (dots per inch) and you will double the image size later, change the resolution setting to 600 dpi.

Note: Higher resolution settings result in larger file sizes, which take longer to process and print. Consider the limitations of your computer system when selecting a resolution, and select the lowest possible resolution that produces acceptable quality to keep file sizes manageable.

Parent topic: [Solving Print Quality Problems](#)

Related concepts

[Print Head Nozzle Check](#)

[Print Head Cleaning](#)

[Print Head Alignment](#)

Related tasks

[Selecting Basic Print Settings - Windows](#)

[Selecting Additional Layout and Print Options - Windows](#)

[Selecting Basic Print Settings - OS X](#)

[Selecting Printing Preferences - OS X](#)

Incorrect Colors

If your printouts have incorrect colors, try these solutions:

- Make sure the paper type setting matches the paper you loaded.
- Make sure the **Black/Grayscale** or **Grayscale** setting is not selected in your printer software.
- Run a nozzle check to see if any of the print head nozzles are clogged. Then clean the print head, if necessary.
- The ink levels may be low and you may need to refill the ink. Visually check the ink levels. Also make sure you filled the tanks with the correct colors of ink.
- After you print, the colors in your printout need time to set as the ink dries. During this time, the colors may look different than you expect. To speed up drying time, do not stack your printouts on top of each other.
- Your printed colors can never exactly match your on-screen colors. However, you can use a color management system to get as close as possible. Try using the color management options in your printer software.
- For best results, use genuine Epson ink and paper.
- If you have not used the product for a long time, run the Power Ink Flushing utility.

Note: Flushing the ink tubes replaces all the ink inside the tubes, so flush the ink only if you cannot improve print quality by other means. See the ink flushing section for details.

Parent topic: [Solving Print Quality Problems](#)

Related concepts

[Print Head Nozzle Check](#)

[Print Head Cleaning](#)

[Power Ink Flushing](#)

Related references

[Available Epson Papers](#)

Related tasks

[Selecting Basic Print Settings - Windows](#)

[Selecting Additional Layout and Print Options - Windows](#)

[Selecting Basic Print Settings - OS X](#)

[Managing Color - OS X](#)

Related topics

[Refilling Ink](#)

Solving Scanning Problems

Check these solutions if you have problems scanning with your product.

[Scanning Software Does Not Operate Correctly](#)

[Cannot Start Epson Scan](#)

Parent topic: [Solving Problems](#)

Scanning Software Does Not Operate Correctly

If your scanning software does not operate correctly, try these solutions:

- Make sure your computer has adequate memory and meets the system requirements for your operating system.
- Make sure your computer is not running in a power-saving mode, such as sleep or standby. If so, wake your system and restart your scanning software.
- If you upgraded your operating system but did not reinstall your scanning software, try reinstalling it.

Note: With OS X, in addition to scanning with Image Capture, you can download and install Epson Scan scanning software. Epson Scan provides additional image adjustment and photo correction features for enhancing scanned images, and provides an interface for TWAIN-compliant OCR scanning software. To download Epson Scan, visit Epson's driver download site ([U.S. downloads](#) or [Canadian downloads](#)).

Parent topic: [Solving Scanning Problems](#)

Related concepts

[Uninstall Your Product Software](#)

Related references

[Windows System Requirements](#)

[OS X System Requirements](#)

Related tasks

[Scanning with OS X Using Image Capture](#)

Cannot Start Epson Scan

If you cannot start Epson Scan, try these solutions:

- Make sure your product is turned on and any interface cables are securely connected at both ends.
- Make sure Epson Scan is selected in your scanning program.
- Make sure your computer is not running in a power-saving mode, such as sleep or standby. If so, wake your system and restart Epson Scan.
- Check the connection setting and test the connection using Epson Scan Settings:

Windows 8.x: Navigate to the **Apps** screen and select **EPSON Scan Settings**. Make sure the correct **Connection** setting is selected, then click the **Test** button.

Windows (other versions): Click  or **Start > All Programs** or **Programs > EPSON > EPSON Scan > EPSON Scan Settings**. Make sure the correct **Connection** setting is selected, then click the **Test** button.

OS X: Open the **Applications** folder, click **Epson Software**, and click **EPSON Scan Settings**. Make sure the correct **Connection** setting is selected, then click the **Test** button.

- Make sure you do not have multiple versions of Epson Scan installed. If you do, uninstall both versions and install one version.
- If you upgraded your operating system but did not reinstall Epson Scan, try reinstalling it.

Note: With OS X, in addition to scanning with Image Capture, you can download and install Epson Scan scanning software. Epson Scan provides additional image adjustment and photo correction features for enhancing scanned images, and provides an interface for TWAIN-compliant OCR scanning software. To download Epson Scan, visit Epson's driver download site ([U.S. downloads](#) or [Canadian downloads](#)).

Parent topic: [Solving Scanning Problems](#)

Related tasks

[Scanning with OS X Using Image Capture](#)

Related topics

[Starting a Scan](#)

Solving Scanned Image Quality Problems

Check these sections if a scanned image on your computer screen has a quality problem.

[Image Consists of a Few Dots Only](#)

[Line of Dots Appears in All Scanned Images](#)
[Straight Lines in an Image Appear Crooked](#)
[Image is Distorted or Blurry](#)
[Image Colors are Patchy at the Edges](#)
[Image is Too Dark](#)
[Back of Original Image Appears in Scanned Image](#)
[Ripple Patterns Appear in an Image](#)
[Image is Scanned Upside-Down](#)
[Scanned Image Colors Do Not Match Original Colors](#)
[Scan Area is Not Adjustable in Thumbnail Preview](#)
[Scanned Image Edges are Cropped](#)

Parent topic: [Solving Problems](#)

Related topics

[Solving Print Quality Problems](#)

Image Consists of a Few Dots Only

If your scanned image consists only of a few dots, try these solutions:

- Make sure you placed your original for scanning facing the correct way.
- If you are scanning using the Epson Scan **Black & White** setting, adjust the **Threshold** setting and scan again.

Parent topic: [Solving Scanned Image Quality Problems](#)

Related references

[Available Image Adjustments - Full Auto Mode](#)

[Available Image Adjustments - Home Mode](#)

[Available Image Adjustments - Office Mode](#)

[Available Image Adjustments - Professional Mode](#)

Related tasks

[Placing Originals on the Scanner Glass](#)

Line of Dots Appears in All Scanned Images

If a line of dots appears in all your scanned images, clean the scanner glass with a soft, dry, lint-free cloth or use a small amount of glass cleaner on the cloth, if necessary. Paper towels are not recommended.

Caution: Do not spray glass cleaner directly on the scanner glass.

Parent topic: [Solving Scanned Image Quality Problems](#)

Related tasks

[Cleaning Your Product](#)

Straight Lines in an Image Appear Crooked

If straight lines in an original appear crooked in a scanned image, make sure to place your original straight when you scan it.

Parent topic: [Solving Scanned Image Quality Problems](#)

Related tasks

[Placing Originals on the Scanner Glass](#)

Image is Distorted or Blurry

If a scanned image appears distorted or blurry, try these solutions:

- Make sure your original is not wrinkled or warped. This may prevent the original from laying flat on the scanner glass.
- Do not move your original or your product during scanning.
- Your product will not operate properly while tilted at an angle. Place your product on a flat, stable surface that extends beyond its base in all directions.
- Adjust these Epson Scan settings (if available) and try scanning again:
 - Select the **Unsharp Mask** setting.
 - Adjust the **Auto Exposure** setting.
 - Increase the **Resolution** setting.

Parent topic: [Solving Scanned Image Quality Problems](#)

Related tasks

[Placing Originals on the Scanner Glass](#)

Related topics

[Selecting Epson Scan Settings](#)

Image Colors are Patchy at the Edges

If you are scanning a thick or warped original, cover its edges with paper to block external light as you scan it.

Parent topic: [Solving Scanned Image Quality Problems](#)

Image is Too Dark

If your scanned image is too dark, try these solutions:

- Adjust these Epson Scan settings (if available) and try scanning again:
 - **Auto Exposure**
 - **Brightness**
 - **Histogram Adjustment**
- Check the brightness and contrast settings of your computer monitor.

Parent topic: [Solving Scanned Image Quality Problems](#)

Related topics

[Selecting Epson Scan Settings](#)

Back of Original Image Appears in Scanned Image

If an image from the back of a thin original appears in your scanned image, place a piece of black paper on the back of the original and scan it again.

Parent topic: [Solving Scanned Image Quality Problems](#)

Ripple Patterns Appear in an Image

You may see a ripple pattern (called a moiré) in scanned images of printed documents. This is caused by interference from differing pitches in the scanner's screen and your original's halftone screen. To reduce this effect, adjust these Epson Scan settings (if available) and try scanning again:

- Select the **Descreening** setting.
- Select a lower **Resolution** setting.

Parent topic: [Solving Scanned Image Quality Problems](#)

Related topics

[Selecting Epson Scan Settings](#)

Image is Scanned Upside-Down

Your product scans using the **Auto Photo Orientation** setting. This setting checks the preview image for faces, the sky, and other features, and then correctly rotates the photo when it is scanned, if necessary. If your photo is not oriented correctly using this option, deselect the **Auto Photo Orientation** setting and scan again.

Note: **Auto Photo Orientation** will not work when you scan newspapers, magazines, documents, illustrations, or line art, or images smaller than 2 inches (5.1 cm) on any side.

Parent topic: [Solving Scanned Image Quality Problems](#)

Related topics

[Selecting Epson Scan Settings](#)

Scanned Image Colors Do Not Match Original Colors

Printed colors can never exactly match the colors on your computer monitor because printers and monitors use different color systems: monitors use RGB (red, green, and blue) and printers typically use CMYK (cyan, magenta, yellow, and black).

Check the color matching and color management capabilities of your computer, display adapter, and the software you are using to see if they are affecting the palette of colors you see on your screen.

To adjust the colors in your scanned image, adjust these Epson Scan settings (if available) and try scanning again:

- Change the **Image Type** setting and experiment with different combinations of the next settings.
- Adjust the **Tone Correction** setting.
- Adjust the **Auto Exposure** setting.

Parent topic: [Solving Scanned Image Quality Problems](#)

Related topics

[Selecting Epson Scan Settings](#)

Scan Area is Not Adjustable in Thumbnail Preview

If you cannot adjust the scan area while viewing a Thumbnail preview in Epson Scan, try these solutions:

- Create a scan area by drawing a marquee on your preview image and adjusting it as necessary.
- Switch to Normal preview mode, if available, and preview your image again.

Parent topic: [Solving Scanned Image Quality Problems](#)

Related concepts

[Image Preview Guidelines](#)

Related tasks

[Selecting a Scan Area - Home Mode](#)

[Selecting a Scan Area - Office Mode](#)

[Selecting a Scan Area - Professional Mode](#)

Scanned Image Edges are Cropped

If the edges of a scanned image are cropped, make sure your original is placed correctly for scanning. If necessary, move your original away from the edges of the scanner glass slightly.

Parent topic: [Solving Scanned Image Quality Problems](#)

Related tasks

[Placing Originals on the Scanner Glass](#)

Uninstall Your Product Software

If you have a problem that requires you to uninstall and re-install your software, follow the instructions for your operating system.

[Uninstalling Product Software - Windows](#)

[Uninstalling Product Software - OS X](#)

Parent topic: [Solving Problems](#)

Uninstalling Product Software - Windows

You can uninstall and then re-install your product software to solve certain problems.

1. Turn off the product.
2. Disconnect any interface cables.
3. Do one of the following:
 - **Windows 8.x:** Navigate to the **Apps** screen and select **Control Panel > Programs > Programs and Features**. Select the uninstall option for your Epson product, then select **Uninstall/Change**.

Note: If you see a **User Account Control** window, click **Yes** or **Continue**.

Select your product again, if necessary, then select **OK**, and click **Yes** to confirm the uninstallation.

- **Windows (other versions):** Click  or **Start**, and select **All Programs** or **Programs**. Select **EPSON**, select your product, then click **EPSON Printer Software Uninstall**.

Note: If you see a **User Account Control** window, click **Yes** or **Continue**.

In the next window, select your product and click **OK**. Then follow any on-screen instructions.

4. Do one of the following to uninstall Epson Event Manager, then follow any on-screen instructions:
 - **Windows 8.x:** Select **Epson Event Manager** and click **Uninstall**.
 - **Windows 7/Windows Vista:** Open the Windows **Control Panel** utility. Select **Programs and Features**. (In Classic view, select **Programs** and click **Uninstall a program**.) Select **Epson Event Manager** and click **Uninstall/Change**.
 - **Windows XP:** Open the Windows **Control Panel** utility. Double-click **Add or Remove Programs**. Select **Epson Event Manager** and click **Change/Remove**.
5. Do one of the following to uninstall Epson Scan, then follow any on-screen instructions:
 - **Windows 8.x/Windows 7/Windows Vista:** Select **EPSON Scan** and click **Uninstall/Change**.
 - **Windows XP:** Select **EPSON Scan** and click **Change/Remove**.
6. Restart your computer, then see the *Start Here* sheet to re-install your software.

Note: If you find that re-installing your product software does not solve a problem, contact Epson.

Parent topic: [Uninstall Your Product Software](#)

Uninstalling Product Software - OS X

In most cases, you do not need to uninstall your product software before re-installing it. However, you can download the Uninstaller utility from the Epson support website to uninstall your product software as described here.

Note: If you find that re-installing your product software does not solve a problem, contact Epson.

1. To download the Uninstaller utility, visit the Epson download site ([U.S. downloads](#) or [Canadian downloads](#)).
2. Follow the instructions on the screen to install the Uninstaller utility.
3. Quit all applications currently running on your Mac.
4. Double-click the **Uninstaller** icon.

5. Select the checkbox for each software program you want to uninstall.
6. Click **Uninstall**.
7. Follow the on-screen instructions to uninstall the software.
8. To reinstall your product software, see the *Start Here* sheet for instructions.

Note: If you uninstall the printer driver and your product name remains in the **Print & Fax, Print & Scan,** or **Printers & Scanners** window, select your product name and click the – (remove) icon to remove it.

Parent topic: [Uninstall Your Product Software](#)

Where to Get Help

If you need to contact Epson for technical support services, use the following support options.

Internet Support

Visit Epson's support website at epson.com/support (U.S.) or epson.ca/support (Canada) for solutions to common problems. You can download drivers and documentation, get FAQs and troubleshooting advice, or e-mail Epson with your questions.

Speak to a Support Representative

Before you call Epson for support, please have the following information ready:

- Product name
- Product serial number (located on a label on the product)
- Proof of purchase (such as a store receipt) and date of purchase
- Computer configuration
- Description of the problem

Then call:

- U.S.: (562) 276-4382, 6 AM to 8 PM, Pacific Time, Monday through Friday, and 7 AM to 4 PM, Pacific Time, Saturday
- Canada: (905) 709-3839, 6 AM to 8 PM, Pacific Time, Monday through Friday, and 7 AM to 4 PM, Pacific Time, Saturday

Days and hours of support are subject to change without notice. Toll or long distance charges may apply.

Purchase Supplies and Accessories

You can purchase genuine Epson ink and paper at [epson.com/ink3](https://www.epson.com/ink3) (U.S. sales) or [epson.ca](https://www.epson.ca) (Canadian sales). You can also purchase supplies from an Epson authorized reseller. To find the nearest one, call 800-GO-EPSON (800-463-7766).

Parent topic: [Solving Problems](#)

Technical Specifications

These sections list the technical specifications for your product.

Note: Epson offers a recycling program for end of life products. Please go to [this site](#) for information on how to return your products for proper disposal.

[Windows System Requirements](#)

[OS X System Requirements](#)

[Scanning Specifications](#)

[Paper Specifications](#)

[Printable Area Specifications](#)

[Ink Specifications](#)

[Dimension Specifications](#)

[Electrical Specifications](#)

[Environmental Specifications](#)

[Interface Specifications](#)

[Network Interface Specifications](#)

[Safety and Approvals Specifications](#)

Windows System Requirements

To use your product and its software, your computer should use one of these Microsoft operating systems:

- Windows 10
- Windows 8.x
- Windows 7
- Windows Vista
- Windows XP Professional x64 Edition
- Windows XP SP3

Note: Visit Epson's support website at epson.com/support (U.S.) or epson.ca/support (Canada) for the latest in compatibility and drivers for your product.

Parent topic: [Technical Specifications](#)

OS X System Requirements

To use your product and its software, your Mac should use one of these operating systems:

- OS X 10.10.x
- OS X 10.9.x
- OS X 10.8.x
- OS X 10.7.x
- OS X 10.6.8

Note: Visit Epson's support website at epson.com/support (U.S.) or epson.ca/support (Canada) for the latest in compatibility and drivers for your product.

Parent topic: [Technical Specifications](#)

Scanning Specifications

Scanner type	Flatbed
Photoelectric device	CIS
Maximum document size	8.5 × 11.7 inches (216 × 297 mm) US letter or A4
Scanning resolution	1200 dpi (main scan) 2400 dpi (sub scan)

Color depth

Color:

48 bits per pixel internal (16 bits per pixel per color internal)

24 bits per pixel external (8 bits per pixel per color external)

Grayscale:

16 bits per pixel internal

8 bits per pixel external

Black-and-white:

16 bits per pixel internal

1 bit per pixel external

Light source

LED

Parent topic: [Technical Specifications](#)

Paper Specifications

Note: Since the quality of any particular brand or type of paper may be changed by the manufacturer at any time, Epson cannot guarantee the quality of any non-Epson brand or type of paper. Always test a sample of paper stock before purchasing large quantities or printing large jobs.

Single-sheets**Paper types**

Plain paper and paper distributed by Epson

WeightPlain paper: 17 lb (64 g/m²) to 24 lb (90 g/m²)**Envelopes****Size**

No. 10 (4.1 × 9.5 inches [105 × 241 mm])

Weight20 lb (75 g/m²) to 24 lb (90 g/m²)Parent topic: [Technical Specifications](#)

Printable Area Specifications

Note: Print quality may decline in the shaded areas shown here due to the printer mechanism.

Single sheets - normal printing

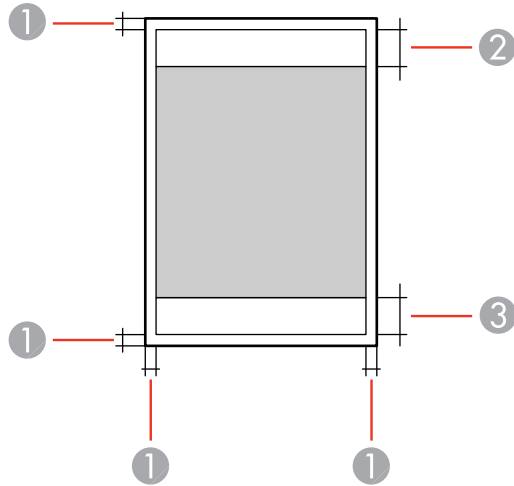

- 1 Margin: 0.12 inch (3 mm) minimum
- 2 Reduced print quality area/top: 1.57 inch (40 mm) minimum
- 3 Reduced print quality area/bottom: 1.26 inch (32 mm) minimum

Envelopes

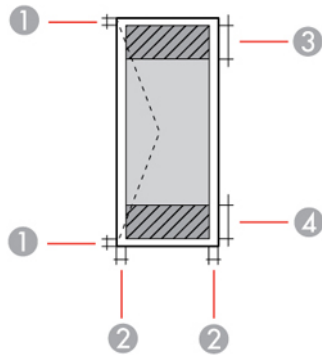

- 1 Left/right margins: 0.12 inch (3 mm) minimum
- 2 Top/bottom margins: 0.20 inch (5 mm) minimum
- 3 Reduced print quality area/right: 0.71 inch (18 mm) minimum
- 4 Reduced print quality area/left: 1.57 inch (40 mm) minimum

Parent topic: [Technical Specifications](#)

Ink Specifications

Note: This product is designed to work with genuine Epson inks. Non-Epson ink or any other ink not specified for this printer could cause damage not covered by Epson's warranties.

The included initial ink bottles must be used for printer setup and are not for resale. The printer ships with full ink bottles and part of the ink from the first bottles is used to charge the print head. Yields vary considerably based on images printed, print settings, paper type, frequency of use and temperature.

Color

Black, Cyan, Magenta, Yellow

Ink life

For best results, use up ink within 6 months of removing the seal from an ink bottle

Temperature

Storage: -4 to 104 °F (-20 to 40 °C)

1 month at 104 °F (40 °C)

Ink freezes at 5 °F (-15 °C)

Ink thaws and is usable after 2 hours at 77 °F (25 °C)

Parent topic: [Technical Specifications](#)**Related concepts**[Purchase Epson Ink](#)

Dimension Specifications

Height

Stored: 6.3 inches (161 mm)

Printing: 11.6 inches (295 mm)

Width

Stored: 19.3 inches (489 mm)

Printing: 19.3 inches (489 mm)

Depth

Stored: 11.8 inches (300 mm)

Printing: 20.7 inches (527 mm)

Weight

10.1 lb (4.6 kg)

(without ink and power cord)

Parent topic: [Technical Specifications](#)

Electrical Specifications

Power supply rating

100 to 240 V

Rated frequency range

50/60 Hz

Rated current

0.5 to 0.3 A

Power consumption

Standalone copying: Approximately 11 W (ISO/IEC24712)

(USB connection)

Ready mode: Approximately 3.6 W

Sleep mode: Approximately 1.3 W

Power off mode: Approximately 0.3 W

Parent topic: [Technical Specifications](#)

Environmental Specifications

Temperature	Operating: 50 to 95 °F (10 to 35 °C) Storage: –4 to 104 °F (–20 to 40 °C) 1 month at 104 °F (40 °C)
Humidity (without condensation)	Operating: 20 to 80% RH Storage: 5 to 85% RH

Parent topic: [Technical Specifications](#)

Interface Specifications

One Hi-Speed USB port for a computer

Parent topic: [Technical Specifications](#)

Network Interface Specifications

Wi-Fi

Standards	IEEE 802.11 b/g/n
Security	WEP (64/128 bit) WPA-PSK (AES); complies with WPA2 with support for WPA/WPA2 Personal
Frequency range	2.4 GHz
Coordination modes	Infrastructure mode Ad hoc mode (not supported for IEEE 802.11n)

Security Protocol

SSL/TLS: HTTPS Client

Parent topic: [Technical Specifications](#)

Safety and Approvals Specifications

United States

Safety: UL60950-1

EMC: FCC part 15 Subpart B class B

Canada

Safety: CAN/CSA C22.2 No. 60950-1

EMC: CAN/CSA-CEI/IEC CISPR 22 Class B

This equipment contains the following wireless module:

- Manufacturer: Askey Computer Corporation.
- Type: WLU6320-D69 (RoHS)

This product conforms to Part 15 of FCC Rules and RSS-210 of the IC Rules. Epson cannot accept responsibility for any failure to satisfy the protection requirements resulting from a non-recommended modification of the product. Operation is subject to the following two conditions: (1) this device may not cause harmful interference, and (2) this device must accept any interference received, including interference that may cause undesired operation of the device.

To prevent radio interference to the licensed service, this device is intended to be operated indoors and away from windows to provide maximum shielding. Equipment (or its transmit antenna) that is installed outdoors is subject to licensing.

This equipment complies with FCC/IC radiation exposure limits set forth for an uncontrolled environment and meets the FCC radio frequency (RF) Exposure Guidelines in Supplement C to OET65 and RSS-102 of the IC radio frequency (RF) Exposure rules. This equipment should be installed and operated so that the radiator is kept at least 7.9 inches (20 cm) or more away from a person's body (excluding extremities: hands, wrists, feet and ankles).

Parent topic: [Technical Specifications](#)

Notices

Check these sections for important notices about your product.

Note: Epson offers a recycling program for end of life products. Please go to [this site](#) for information on how to return your products for proper disposal.

[Important Safety Instructions](#)

[FCC Compliance Statement](#)

[Trademarks](#)

[Copyright Notice](#)

Important Safety Instructions

Before using your Epson product, read and follow these safety instructions.

[General Product Safety Instructions](#)

[Wireless Connection Safety Instructions](#)

Parent topic: [Notices](#)

Related references

[Ink Safety Precautions](#)

General Product Safety Instructions

- Be sure to follow all warnings and instructions marked on the product.
- Use only the type of power source indicated on the product's label.
- Use only the power cord that comes with the product. Use of another cord may cause fires or shock. Do not use the cord with any other equipment.
- Place the product near a wall outlet where the plug can be easily unplugged.
- Avoid plugging the product into an outlet on the same circuit as a photo copier or air control system that regularly switches on and off, or on an outlet controlled by a wall switch or timer.
- Do not let the power cord become damaged or frayed. Place it to avoid abrasions, cuts, fraying, crimping, and kinking. Do not place objects on top of it and do not allow it to be stepped on or run over. Be careful to keep the cord straight at each end.
- If you use an extension cord with the product, make sure the total ampere rating of the devices plugged into the extension cord does not exceed the cord's ampere rating. Also, make sure the total

ampere rating of all devices plugged into the wall outlet does not exceed the wall outlet's ampere rating.

- Always turn off the product using the power button, and wait until the power light stops flashing before unplugging the product or cutting off power to the electrical outlet.
- If you will not be using the product for a long period, unplug the power cord from the electrical outlet.
- Place the product on a flat, stable surface that extends beyond its base in all directions. It will not operate properly if it is tilted or at an angle.
- Allow space behind the product for the cables, and space above the product so that you can fully raise the document cover.
- Leave enough space in front of the product for the paper to be fully ejected.
- Avoid locations that are subject to rapid changes in heat or humidity, shocks or vibrations, or dust.
- Do not place or store the product outdoors.
- Do not place the product near excessive heat sources or in direct sunlight.
- Leave enough room around the product for sufficient ventilation. Do not block or cover openings in the case or insert objects through the slots.
- Keep the product away from potential sources of electromagnetic interference, such as loudspeakers or the base units of cordless telephones.
- When connecting the product to a computer or other device with a cable, ensure the correct orientation of the connectors. Each connector has only one correct orientation. Inserting a connector in the wrong orientation may damage both devices connected by the cable.
- Do not touch the flat white cable inside the product.
- Do not move the print head by hand; this may damage the product.
- Do not spill liquid on the product or use the product with wet hands.
- Do not use aerosol products that contain flammable gases inside or around the product. Doing so may cause fire.
- Do not press too hard on the document table when placing originals.
- Do not open the scanner section while the product is copying, printing, scanning, or performing any other functions.
- Be careful not to trap your fingers when closing the document cover or scanner.
- Except as specifically explained in your documentation, do not attempt to service the product yourself.
- Unplug the product and refer servicing to qualified service personnel under the following conditions: if the power cord or plug is damaged; if liquid has entered the product; if the product has been dropped

or the case damaged; if the product does not operate normally or exhibits a distinct change in performance. Adjust only those controls that are covered by the operating instructions.

- Before transporting the product, make sure that the print head is in the home (far right) position.
- When storing or transporting the product, do not tilt it, stand it on its side, or turn it upside down; otherwise ink may leak.

Parent topic: [Important Safety Instructions](#)

Wireless Connection Safety Instructions

Radio waves from this product may adversely affect the operation of medical equipment or automatically controlled devices, such as pacemakers, automatic doors or fire alarms. When using this product near such devices or inside a medical facility, follow the directions from authorized staff members at the facility, and follow all posted warnings and directions on the device to avoid causing an accident.

Parent topic: [Important Safety Instructions](#)

FCC Compliance Statement

For United States Users

This equipment has been tested and found to comply with the limits for a Class B digital device, pursuant to Part 15 of the FCC Rules. These limits are designed to provide reasonable protection against harmful interference in a residential installation. This equipment generates, uses, and can radiate radio frequency energy and, if not installed and used in accordance with the instructions, may cause harmful interference to radio or television reception. However, there is no guarantee that interference will not occur in a particular installation. If this equipment does cause interference to radio and television reception, which can be determined by turning the equipment off and on, the user is encouraged to try to correct the interference by one or more of the following measures:

- Reorient or relocate the receiving antenna.
- Increase the separation between the equipment and receiver.
- Connect the equipment into an outlet on a circuit different from that to which the receiver is connected.
- Consult the dealer or an experienced radio/TV technician for help.

WARNING

The connection of a non-shielded equipment interface cable to this equipment will invalidate the FCC Certification or Declaration of this device and may cause interference levels which exceed the limits established by the FCC for this equipment. It is the responsibility of the user to obtain and use a shielded equipment interface cable with this device. If this equipment has more than one interface connector, do

not leave cables connected to unused interfaces. Changes or modifications not expressly approved by the manufacturer could void the user's authority to operate the equipment.

For Canadian Users

CAN ICES-3(B)/NMB-3(B)

Parent topic: [Notices](#)

Trademarks

EPSON® is a registered trademark, EPSON Exceed Your Vision is a registered logomark, and Epson Connect™ is a trademark of Seiko Epson Corporation.

Epson iPrint™ and Remote Print™ are trademarks of Seiko Epson Corporation.

Apple, iPad, iPhone, iPod touch, Mac, and OS X are trademarks of Apple Inc., registered in the U.S. and other countries. AirPrint and the AirPrint logo are trademarks of Apple Inc.

Google® is a registered trademark and Android™, Chromebook™, Gmail™, Google Chrome™, Google Cloud Print™, and Google Drive™ are trademarks of Google Inc.

General Notice: Other product names used herein are for identification purposes only and may be trademarks of their respective owners. Epson disclaims any and all rights in those marks.



Parent topic: [Notices](#)

Copyright Notice

All rights reserved. No part of this publication may be reproduced, stored in a retrieval system, or transmitted in any form or by any means, electronic, mechanical, photocopying, recording, or otherwise, without the prior written permission of Seiko Epson Corporation. The information contained herein is designed only for use with this Epson product. Epson is not responsible for any use of this information as applied to other products.

Neither Seiko Epson Corporation nor its affiliates shall be liable to the purchaser of this product or third parties for damages, losses, costs, or expenses incurred by purchaser or third parties as a result of: accident, misuse, or abuse of this product or unauthorized modifications, repairs, or alterations to this product, or (excluding the U.S.) failure to strictly comply with Seiko Epson Corporation's operating and maintenance instructions.

Seiko Epson Corporation shall not be liable for any damages or problems arising from the use of any options or any consumable products other than those designated as Original Epson Products or Epson Approved Products by Seiko Epson Corporation.

Seiko Epson Corporation shall not be held liable for any damage resulting from electromagnetic interference that occurs from the use of any interface cables other than those designated as Epson approved Products by Seiko Epson Corporation.

This information is subject to change without notice.

[A Note Concerning Responsible Use of Copyrighted Materials](#)

[Default Delay Times for Power Management for Epson Products](#)

[Copyright Attribution](#)

Parent topic: [Notices](#)

A Note Concerning Responsible Use of Copyrighted Materials

Epson encourages each user to be responsible and respectful of the copyright laws when using any Epson product. While some countries' laws permit limited copying or reuse of copyrighted material in certain circumstances, those circumstances may not be as broad as some people assume. Contact your legal advisor for any questions regarding copyright law.

Parent topic: [Copyright Notice](#)

Default Delay Times for Power Management for Epson Products

This product will enter sleep mode after a period of nonuse. This is to ensure that the product meets Energy Star standards of energy efficiency. More energy savings can be achieved by setting the time to sleep to a shorter interval.

Parent topic: [Copyright Notice](#)

Copyright Attribution

© 2015 Epson America, Inc.

9/15

CPD-42912R1

Parent topic: [Copyright Notice](#)